

COMPARISON OF INVERTER TYPES FOR HOME APPLIANCE USING PUSH-PULL AMPLIFIER (Experimental Inverter Types at Engineering Laboratory)

by Mokh Hairul Bahri

Submission date: 04-Jun-2021 09:01AM (UTC+0800)

Submission ID: 1599993504

File name: Jurnal_Tambahan_1.pdf (4.16M)

Word count: 2954

Character count: 14784

COMPARISON OF INVERTER TYPES FOR HOME APPLIANCE USING PUSH-PULL AMPLIFIER

(Experimental Inverter Types at Engineering Laboratory)

- 1) Mechanical Engineering
Department, Universitas
Muhammadiyah Jember, Jl.
Karimata 49, Jember,
Indonesia
- 2) Electrical Engineering
Department, Universitas
Muhammadiyah Jember, Jl.
Karimata 49, Jember,
Indonesia.

Corresponding email ¹⁾ :
mhairulbahri@unmuhjember.ac.id

Mokh. Hairul Bahri ¹⁾, Dudi Irawan²⁾

Abstract. This paper deals with a comparison of inverter types and develops a system to provide pure sine wave ac voltage. The ac voltage is utilized to drive the compressor ac split. The assembled inverter problem is a square waveform, power losses, torque, efficiency, and a lag behind in terms of performance reliability. The push-pull amplifiers technic is proposed to produce sine wave output from dc input. The output result shows that an experimental pure sin wave obtains a frequency of 50.05 Hz, V max 13.49 Volt, V min -14.49 volt, and duty cycle 50.1%. the assembled inverter has a frequency is 37.87 Hz, V max 11.88 Volt, V min 13.09 volt, and a duty cycle is 50 %. A modified 3-phase inverter attains frequency 50.05 Hz, V max 15.71 Volt, V min -16.11 Volt, and the duty cycle is 50.5 %. The frequency, v max, v min, and duty cycle are bigger than an assembled inverter, then the modified 3-phase inverter has small harmonic distortion. The comparison of inverter types gives information for home appliances.

Keywords: three phase inverter, push-pull amplifier, transformer.

1. INTRODUCTION

The inverter is a popular known as power electronic device that is used for the conversion of dc to ac at various voltage and frequency by switching and control circuits. An output voltage can be supplied by a dc source such as batteries, capacitors, and solar panels [1]. A voltage source inverter is utilized to vary the supply voltage and frequency. The voltage source inverter is independently controlled by ac output voltage waveforms. Three-phase inverter is high-power applications which are widely used in motor drive, air conditioning, and compressor systems with switching a capacitor [2]. Power electronics have contributed to developing new powerful applications, these advances have increased the harmonic contamination present line current which ends up distorting the voltage waveforms [3]. For high-efficiency, dc-ac conversion and peak power tracking must have low harmonic distortion and high power [4]. A capacitor has capacitance with a range of 500-5000 μF to keep voltage constant (V_{dc}) at the large capacitance in input current (I_{in}) is severely distorted and power input is low. Furthermore, the use of capacitors has a weakness in reliability [5]. The type of load home appliance is non-linear load. An inverter shall affect a lot of non-linear loads such as water pumps, air conditioning, fans, and refrigerator [6]. The power inverter problem is a square waveform, and a lag behind in terms of performance reliability. The impact of the output inverter is power losses, torque, and efficiency. Moreover, the output sine wave inverter does not achieve to apply home appliance [7].

This paper deals with a comparison of any inverter and develops a system to provide pure sine wave ac voltage. The ac voltage is utilized to drive the compressor ac split. The first measurement of the voltage source is done, the second inverter is assembled to produce a pure sine wave, and the third inverter is modified to obtain a pure sine waveform of an inverter. The proposed system uses the push-pull amplifiers technic to produce sine wave output from dc input. The push-pull amplifiers technic is the process to obtain low harmonic distortion and high frequency. Every half of the wave amplifier conducts a one-half cycle of RF signal for operating cycle 10°, then the efficiency attains as high as 78.5%. Consequently, the transistor of the circuit push-pull gets ON more than half a cycle class-B, but less than full cycle like class-A. the device does not change suddenly cut-off to mode linear.

2. METHODS

The push-pull amplifier is used to couple amplifier only ac signal. The amplifier has the infinite gain for differential input signal, and it converts a weak signal for home applications. The device of an amplifier can be designed by varying performance parameters to attain the desired result. Adaptive bias is one of a method to solve slew rate, to increase power transistor, and to produce power consumption [8]. The electronic device requires low voltage and power that it can be attained by operating device of a transistor. a supply voltage from dc source and efficiency power which can be achieved by using a push-pull output in the circuit [9]-[10]. A combination of transistor n-channel and p-channel in series or parallel are used to obtain common-mode input range and to increase low frequency. The open-loop gain in offset voltage is produced by connecting the gain boost amplifier [11].

The amplifier of push-pull has a 1KHz input frequency, low load resistance in the range of few Ohms. The high efficiency and high load resistance in the range of KΩ have been developed using a valve based on the circuit [12]. The circuit of the push-pull amplifier is designed by Proteus 8.0 such as initially high load resistance, compressor split, air conditioning, and home appliance which is fundamental level using an active device to approach ac waveforms output. The design of the component is described in figure 1.

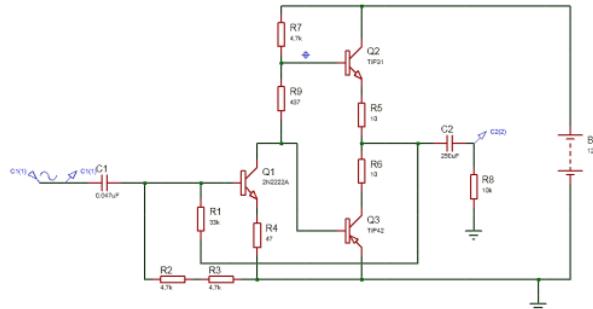

Figure 1. Proposed Push-Pull Amplifier.

The proposed push-pull amplifier in figure 1 is configured by processing dc voltage 12 Volt from a battery source. The Resistance R7 and R9 are placed to series transistor n-channel Q1 2N2222A which input as sinusoidal from the source. Then, the transistor n-channel Q2 TIP31 is series to resistor R5 and R6 that can be switching transistor p-channel Q3 TIP42. The capacitor is parallel between R5 and R6 to obtain desired sine waveform output and a resistor R8 is inverter load. The battery supplies amplifier that the output is depressed by the transformer to 220 Volt. The 12 Volt battery source is connected to an amplifier to produce a sinusoidal waveform with a frequency of 50 Hz to 1 kHz after switching by a transistor. In the output stage push-pull, the supply current is used efficiently. The push-pull is in principle represented by the voltage source, which expresses all its important properties. To set the quiescent current, the sum of the gate-source voltages of the output stage can be controlled in such a way that it is equal to the sum of a reference PNP gate-source voltage and an NPN gate-source voltage, which is obtained by giving the value. Table 1 explains the detailed circuit of components for the push-pull amplifier.

Table 1. Detail Circuits of Component

Variable	Value	Unit
Capacitor (C1)	0.047	uF
Capacitor (C2)	250	uF
Transistor NPN (Q1 2N2222A)	-	H
Transistor NPN (Q2 TIP31)	-	H
Transistor PNP (Q3 TIP42)	-	H
Resistor (R1)	33k	Ω
Resistor (R2)	4.7k	Ω
Resistor (R3)	4.7k	Ω
Resistor (R4)	47	Ω
Resistor (R5)	10	Ω
Resistor (R6)	10	Ω
Resistor (R7)	4.7k	Ω
Resistor (R8)	10k	Ω
Resistor (R9)	437	Ω

3. RESULTS AND DISCUSSION

3.1 Experimental of AC Sine Waveform

Figure 2 describes the experimental AC sine waveform that is conducted by a transformer CT 2A. The experiment is utilized to attain a sine waveform from the AC source, and then a comparison of any inverter applies for compressor split.

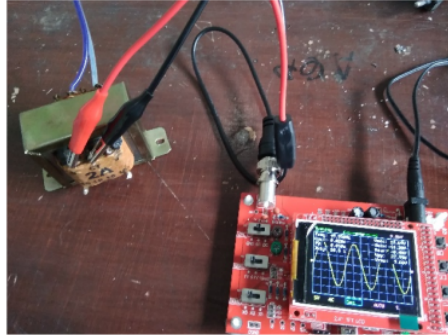

Figure 2. Experimental Sine Waveform of Transformer CT

Figure 3 is an experimental transformer to obtain a sinusoidal waveform. The transformer is supplied by an AC source. This experiment proves a sinusoidal waveform without any load. According to data, every square value is 5 Volt, the frequency is 50 Hz, cycles is 0.019 second, the maximum voltage is 13.49 volt, and the minimum voltage is -14.38 volt.

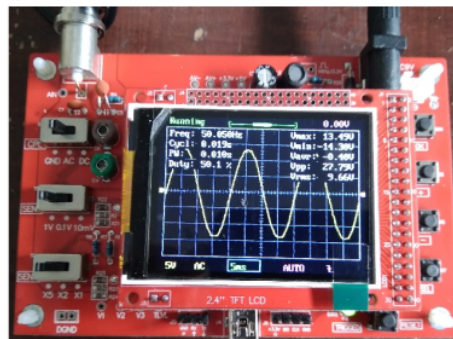

Figure 3. Sinusoidal Waveform of Transformer CT

3.2. Assembled 3-phase Inverter

Figure 4 is assembled 3-phase inverter. The inverter is assembled by a component such as one capacitor 4700 μF , one capacitor 220 μF , one capacitor 10 μF , one capacitor 1 μF , one positive voltage regulator L7808, four IRF 250 N transistors MOSFET, two-transistor NPN C1815, seven diodes IN4007, one resistor 220 ohm, three resistors 10 ohms, one resistor 100 ohm, one IC SG3542N DIP 16 Pin, three resistors 1M ohm, two resistors 10M ohm, one resistor 4M ohm, one transformer CT 10 A, and one transformer 500 mA.



Figure 4. Assembled 3-phase Inverter

Figure 5 is an experimental of an assembled 3-phase inverter. The inverter output does not achieve a sinusoidal waveform. The problem is caused by a voltage drop and high harmonic distortion. Therefore, an inverter does not apply for any home appliance which requires high voltage. Based on the experimental result, the frequency of the assembled 3-phase inverter is 37.87 Hz, the cycle is 0.02 second, maximum voltage 11.88 Volt, the minimum voltage is -13.09 Volt.

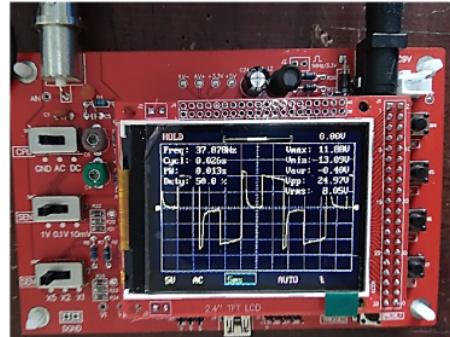

Figure 5. Experimental of Assembled 3-phase Inverter

3.3. Proposed Method of 3-phase Inverter

The proposed method of a 3-phase inverter utilizes a push-pull amplifier. A new concept of the push-pull amplifier is designed by Proteus 8.0 which component assemblies such as batt¹ 12 Volt, resistor, and capacitor. The push-pull amplifier is supplied by dc power to obtain a 12 Volt ac signal source at 1KHz frequency through simulation software. The response of frequency estimates an approach desired sinusoidal waveform. The simulation result is described in figure 6.

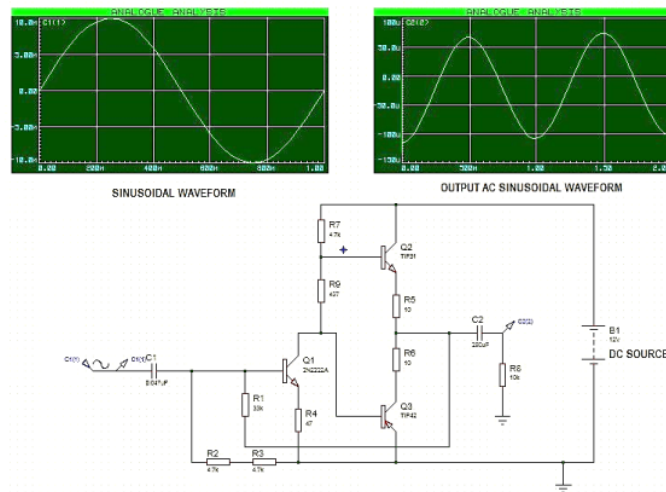

Figure 6. Simulation of Push-Pull Amplifier

Figure 6 the simulation result shows that the proposed method of push-pull amplifier gives sinusoidal waveform with a load resistance RL. An increasing load resistance from 1kΩ to 10kΩ has variation output ac waveform. The capacitor sinusoidal waveform C1 has a maximum voltage of 220 volts, a frequency 1kHz. The acitor output C2 has AC sinusoidal waveform and a frequency 1kHz. An input signal waveform is caused by the transistor Q1 to operate normally in the active reg⁷. Hence, it can decrease crossover distortion. A small collector current flows when the signal input is zero. The transistor Q2 will be ON more than half waveform cycle, but much less than a full cycle is giving a conduction angle between 180° to 360°. The amount of resistor voltage at the terminal of transistor Q3 can be increased several times by adding a series resistor. The output transistor Q1, Q2, and Q3 each half waveform (positive and negative) will be 0.7 Volt. The result two resistors are turn OFF at the same time. A simple way to decrease harmonic distortion is by adding a small voltage to the circuit to refract two-transistor Q2 and Q3.

3.2. Modified Inverter

A modified 3-phase inverter has been designed based on a component that can provide the desired output. The inverter output is an approach of a sinusoidal waveform. The waveform utilizes to drive a compressor sp₉ which needs a pure sine wave. The problem-assembled inverter has a square waveform, and a lag behind in terms of performance reliability. The impact of the output inverter is power losses, torque, and efficiency. Moreover, the output sine wave inverter does not achieve to apply home appliance [7]. To solve this problem, the modified inverter is experimented with by using a push-pull amplifier to obtain a sinusoidal waveform. The experiment is conducted at the laboratory. Figure 7 shows the modified 3-phase inverter.

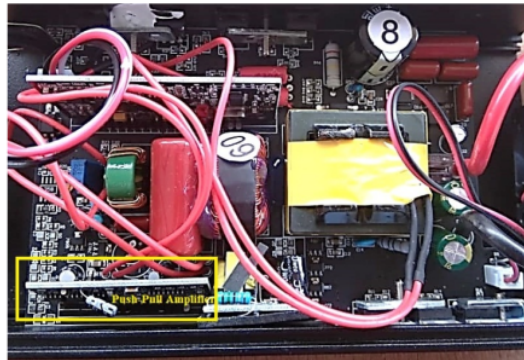

Figure 7. Modified 3-phase Inverter

Figure 8 shows the output 3-phase modified inverter which has a sin waveform of 220 volts. The frequency 50.05 Hz, a cycle becomes 0.019 seconds, a maximum voltage is 15.71 volt, the minimum voltage is -16.11 volt, and root mean square voltage (V_{rms}) is 10.79 volt. The cycle of a square wave is 5 Volt at the time 2 microseconds. The output 3-phase modified inverter can be affected by a push-pull amplifier that is placed a series resistor R7 and R9. The transistor Q2 N-channel is placed by a parallel between R7 and R9 that can decrease harmonic distortion. Then, the transistor Q3 p-channel is connected to a series resistor R5 and R6 to maintain overcurrent from the load.

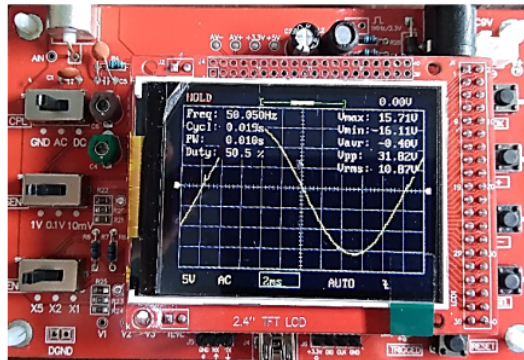

Figure 8. Output 3-phase Modified Inverter.

Table 1. Comparison of Inverter

Inverter	Frequency	V max	V min	Duty Cycle
Pure AC sine wave	50.05 Hz	13.49 V	-14.49 V	50.1 %
Assembled Inverter	37.87 Hz	11.88 V	-13.09 V	50 %
Modified Inverter	50.05 Hz	15.71 V	-16.11 V	50.5 %

Table 1 is a comparison of the output 3-phase inverter. The experimental pure sine wave of transformer

CT 2A obtains a frequency of 50.05 Hz, V max 13.49 Volt, V min -14.49 volt, and duty cycle 50.1%. the assembled inverter has a frequency is 37.87 Hz, V max 11.88 Volt, V min 13.09 volt, and a duty cycle is 50 %. A modified 3-phase inverter attains frequency 50.05 Hz, V max 15.71 Volt, V min -16.11 Volt, and the duty cycle is 50.5 %. The modified 3-phase inverter shows that a sinusoidal waveform output is suitable for a home appliance like compressor split or air conditioning. Therefore, the frequency, v max, v min, and duty cycle are bigger than an assembled inverter, then the modified 3-phase inverter has harmonic distortion is small. The home appliance application requires fewer power losses, and torque to avoid a damaged component.

4. CONCLUSION

The comparison of any inverter is conducted by designing assembled inverter and modified 3-phase inverter. This comparison of any inverter and develops a system to provide pure sine wave ac voltage. The push-pull amplifiers technic proposed to produce sine wave output from dc input. The output result shows that an experiment of pure sin wave obtains a frequency of 50.05 Hz, V max 13.49 Volt, V min -14.49 volt, and duty cycle 50.1%. the assembled inverter has a frequency is 37.87 Hz, V max 11.88 Volt, V min 13.09 volt, and a duty cycle is 50 %. A modified 3-phase inverter attains frequency 50.05 Hz, V max 15.71 Volt, V min -16.11 Volt, and the duty cycle is 50.5 %. Therefore, the frequency, v max, v min, and duty cycle are bigger than an assembled inverter, then the modified 3-phase inverter has small harmonic distortion. The comparison of any 3-phase inverter gives information for home appliances.

5. ACKNOWLEDGMENT

We would like to say thank you very much to:

1. Rector Of Universitas Muhammadiyah Jember and all his staff.
2. Dean of Technical Faculty Of Universitas Muhammadiyah Jember.
3. Head of LPPM Universitas Muhammadiyah Jember for financial supporting in research budget year of 2021.

6. REFERENCES

- [1] B. Bhattacharjee, "Analytical Study of Novel Design Inverter," *Proc. 3rd Int. Conf. Commun. Electron. Syst. ICCES 2018*, no. Icces, pp. 286–290, 2018.
- [2] M. Islam, N. Raju, and A. Ahmed, "Sinusoidal PWM Signal Generation Technique for Three-Phase Voltage Source Inverter with Analog Circuit & Simulation of PWM Inverter for Standalone Load & Micro," *Int. J. Renew. Energy Res.*, vol. 3, no. 3, pp. 647–658, 2013.
- [3] M. López G., L. Morán T., J. Espinoza C., and J. Dixon R., "Performance Analysis of a Hybrid Asymmetric Multilevel Inverter for High Voltage Active Power Filter Applications," *IECON Proc. (Industrial Electron. Conf.)*, vol. 2, pp. 1050–1055, 2003.
- [4] A. Roshan, R. Burgos, A. C. Baisden, F. Wang, and D. Boroyevich, "A D-Q frame controller for a full-bridge single phase inverter used in small distributed power generation systems," *Conf. Proc. - IEEE Appl. Power Electron. Conf. Expo. - APEC*, pp. 641–647, 2007.
- [5] H. S. Jung, S. J. Chee, S. K. Sul, Y. J. Park, H. S. Park, and W. K. Kim, "Control of three-phase inverter for AC motor drive with small DC-Link capacitor fed by single-phase AC source," *IEEE Trans. Ind. Appl.*, vol. 50, no. 2, pp. 1074–1081, 2014.
- [6] R. Fierdaus, I. Soeprapto, I. H. Purnomo, T. Elektro, T. Elektro, and U. Brawijaya, "Pengaruh bentuk gelombang sinus termodifikasi (," pp. 0–5.
- [7] R. Haider, R. Alam, N. B. Yousuf, and K. M. Salim, "Design and construction of single phase pure sine wave inverter for photovoltaic application," *2012 Int. Conf. Informatics, Electron. Vision, ICIEV 2012*, pp. 190–194, 2012.
- [8] M. Santosh Kumar, D. Asha Devi, and P. Snist, "Design of Power Efficient and High Slew Rate Class AB OPAMP," no. November, pp. 6159–6162, 2015.
- [9] P. Anbarasan, K. Hariharan, and R. Parameshwaran, "Design of gain enhanced and power-efficient op-amp for ADC/DAC and medical applications," *Indian J. Sci. Technol.*, vol. 9, no. 29, 2016.
- [10] K. Langen and J. H. Huijsing, "Compact Low Voltage Power Efficient Opamp Cells for VLSI," *Jssc*, vol. 33, no. 10, pp. 1–15, 1998.
- [11] B. Lee, "Low Voltage / Low Power Rail-To-Rail Cmos Operational Amplifier for Portable ECG," no. August 2013.
- [12] S. Shukla, B. Pandey, and S. Srivastava, "New circuit models of Complementary-Symmetry Class-AB and Class-B Push-Pull Amplifiers," *2012 10th IEEE Int. Conf. Semicond. Electron. ICSE 2012 - Proc.*, pp. 538–542, 2012.

COMPARISON OF INVERTER TYPES FOR HOME APPLIANCE USING PUSH-PULL AMPLIFIER (Experimental Inverter Types at Engineering Laboratory)

ORIGINALITY REPORT

16%

SIMILARITY INDEX

10%

INTERNET SOURCES

13%

PUBLICATIONS

7%

STUDENT PAPERS

PRIMARY SOURCES

- 1 SachchidaNand Shukla, Beena Pandey, Susmrita Srivastava. "New circuit models of Complementary-Symmetry Class-AB and Class-B Push-Pull Amplifiers", 2012 10th IEEE International Conference on Semiconductor Electronics (ICSE), 2012
Publication 3%
- 2 Submitted to Politeknik Negeri Sriwijaya
Student Paper 3%
- 3 Langen, Klaas-Jan, and Johan H. Huijsing. "Realizations", Compact Low-Voltage and High-Speed CMOS BiCMOS and Bipolar Operational Amplifiers, 1999.
Publication 3%
- 4 ojs.pnb.ac.id
Internet Source 2%
- 5 www.ijrer.com
Internet Source 2%

6	Bitty Jose, Litty Jose, R Sheril Kiruba, Prachi Medline Ekka, S. Sridevi Sathya Priya. "Two Stage Class AB Op-Amp for Video Applications", 2019 3rd International Conference on Trends in Electronics and Informatics (ICOEI), 2019	1 %
Publication		
7	Submitted to Canterbury College, Kent	1 %
Student Paper		
8	Submitted to Queensland University of Technology	1 %
Student Paper		
9	www.ijew.io	1 %
Internet Source		
10	Hyun-Sam Jung, Seung-Jun Chee, Seung-Ki Sul, Young-Jae Park, Hyun-Soo Park, Woo-Kyu Kim. "Control of three phase inverter for AC motor drive with small DC-link capacitor fed by single phase AC source", 2012 IEEE Energy Conversion Congress and Exposition (ECCE), 2012	<1 %
Publication		
11	Hyun-Sam Jung, Seung-Jun Chee, Seung-Ki Sul, Young-Jae Park, Hyun-Soo Park, Woo-Kyu Kim. "Control of Three-Phase Inverter for AC Motor Drive With Small DC-Link Capacitor Fed by	<1 %

Single-Phase AC Source", IEEE Transactions on Industry Applications, 2014

Publication

12

Sedra, Adel S.. "Microelectronic Circuits",
Oxford University Press

Publication

<1 %

Exclude quotes On

Exclude matches Off

Exclude bibliography On