

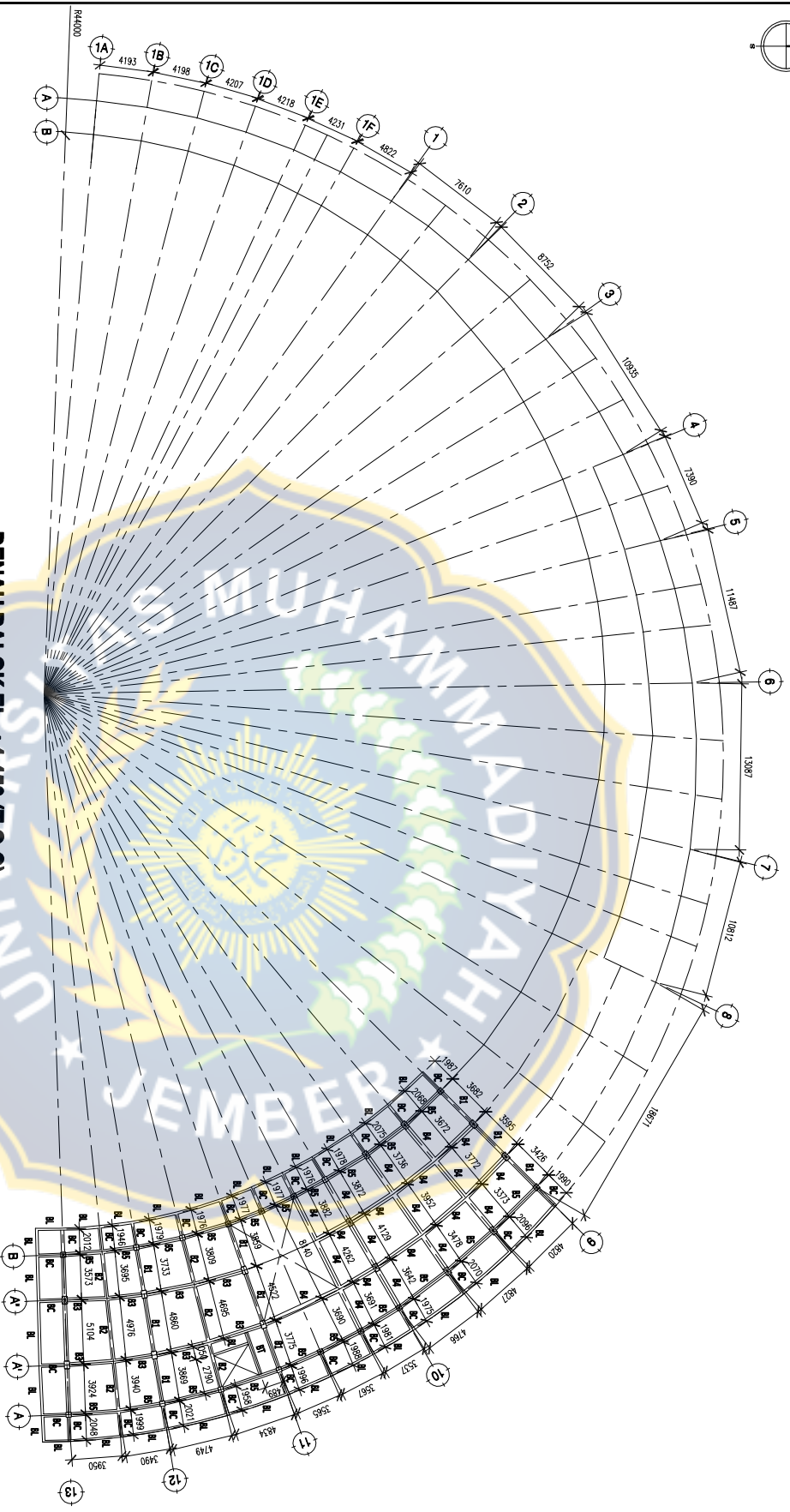

LAMPIRAN



DENAH BALOK EL. +4.450 (T.O.C)
SKALA 1:350

UNIVERSITAS JEMBER

TYPHE	R1		R2		R3		R4		R5		R6		R7	
	TIKUPUN	LAPANGAN	TIKUPUN	LAPANGAN	TIKUPUN	LAPANGAN	TIKUPUN	LAPANGAN	TIKUPUN	LAPANGAN	TIKUPUN	LAPANGAN	TIKUPUN	LAPANGAN
DIMANSI	250x400	250x400	250x500	250x500	350x700	350x700	400x900	400x900	300x500	300x500	250x400	130x500	TIKUPUN	LAPANGAN
TOP MAINSIBAR	5.D16	3.D16	5.D16	3.D16	7.D19	4.D19	9.D19	6.D19	7.D16	4.D16	6.D16	2.D16		
BOT MAIN BAR	3.D16	5.D16	3.D16	5.D16	4.D19	7.D19	6.D19	9.D19	4.D16	7.D16	4.D16	2.D16		
SIFIRIRIBUR BAR	D10x100	D10x150	D10x100	D10x150	D10x100	D10x150	D10x100	D10x150	D10x100	D10x150	D10x100	D10x150		
WIDR BAR	2.D13	2.D13	2.D13	2.D13	2.D13	2.D13	4.D13	4.D13				2.D13		

NOTE

CONCRETE QUALITY :
 BECON
 PILECAP, THE BEAM = K-250
 COLUMN, BEAM, SLAB = K-250
 BESI
 LUKA BUD 40 U40 (BERFORM)
 POLUS BHP 24 U24 (RUM)

DATE	REVISION

THE CONSTRUCTION OF INTEGRATED LABORATORY BUILDING FOR THE FACULTY OF ENGINEERING AND ARCHITECTURE OF THE UNIVERSITY OF JEMBER

PROJECT SUPERVISION CONSULTANT

ENGINEER/ARHITECT/CONSULTANT

CONTRACTOR

PT. PUTRA KARYA - PT. NINDYA KARYA (CV)

APPROVED BY: DATE: SIGN:

DESIGNED BY: DATE: SIGN:

DRAWING TITLE

DIVISION STRUKTUR

DENAH BALOK EL. +4.450 (T.O.C)

SCALE SHEET DRAWING NO. 1:350 1 2 90.878/107

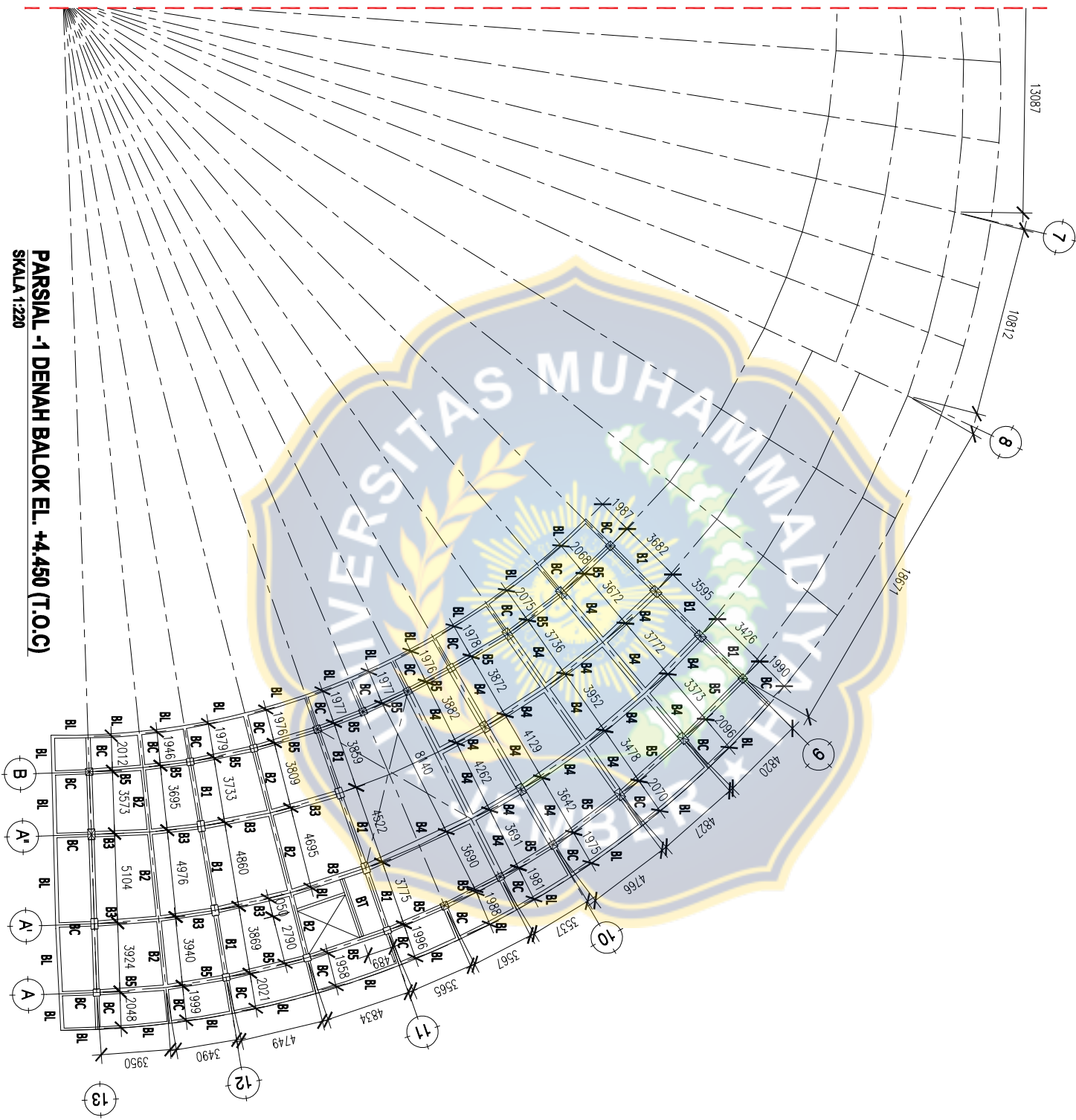

PARSIAL -1 DENAH BALOK EL. +4.450 (T.O.C)
SKALA 1:220

NOTE

- CONCRETE QUANTITY :
- BECON
- PIECAP, THE BEAM = K-250
- COLUMN, BEAM, SLAB = K-250
- RESI
- LINK BOND 40 UMB (BEFORM)
- POLOS BTP 24 U24 (RUM)

DATE	REVISION

THE CONSTRUCTION OF INTEGRATED
 LAMPUNG UNIVERSITY OF TECHNOLOGY
 AND ACADEMY OF THE UNIVERSITY OF JEMBER

PROJECT SUPERVISION CONSULTANT

ENGINEER/ARCHITECT/STRUCTURAL ENGINEER

TEAM LEADER	DATE	SIGN

CONTRACTOR

PT. HUTAJAYA KARYA - PT. NINDYA KARYA (CV)

APPROVED BY	DATE	SIGN

CHIEF BY	DATE	SIGN

DRAWING NO	DATE	SIGN

SHOP DRAWING

DRAWING GROUP
 TRAINING CENTER
 DIVISION
STRUKTUR
 DRAWING TITLE

SCALE	SHEET	DRAWING NO
1:220	2	803TR01A/01A

PARSIAL -1 DENAH BALOK EL. +4.450 (T.O.C)

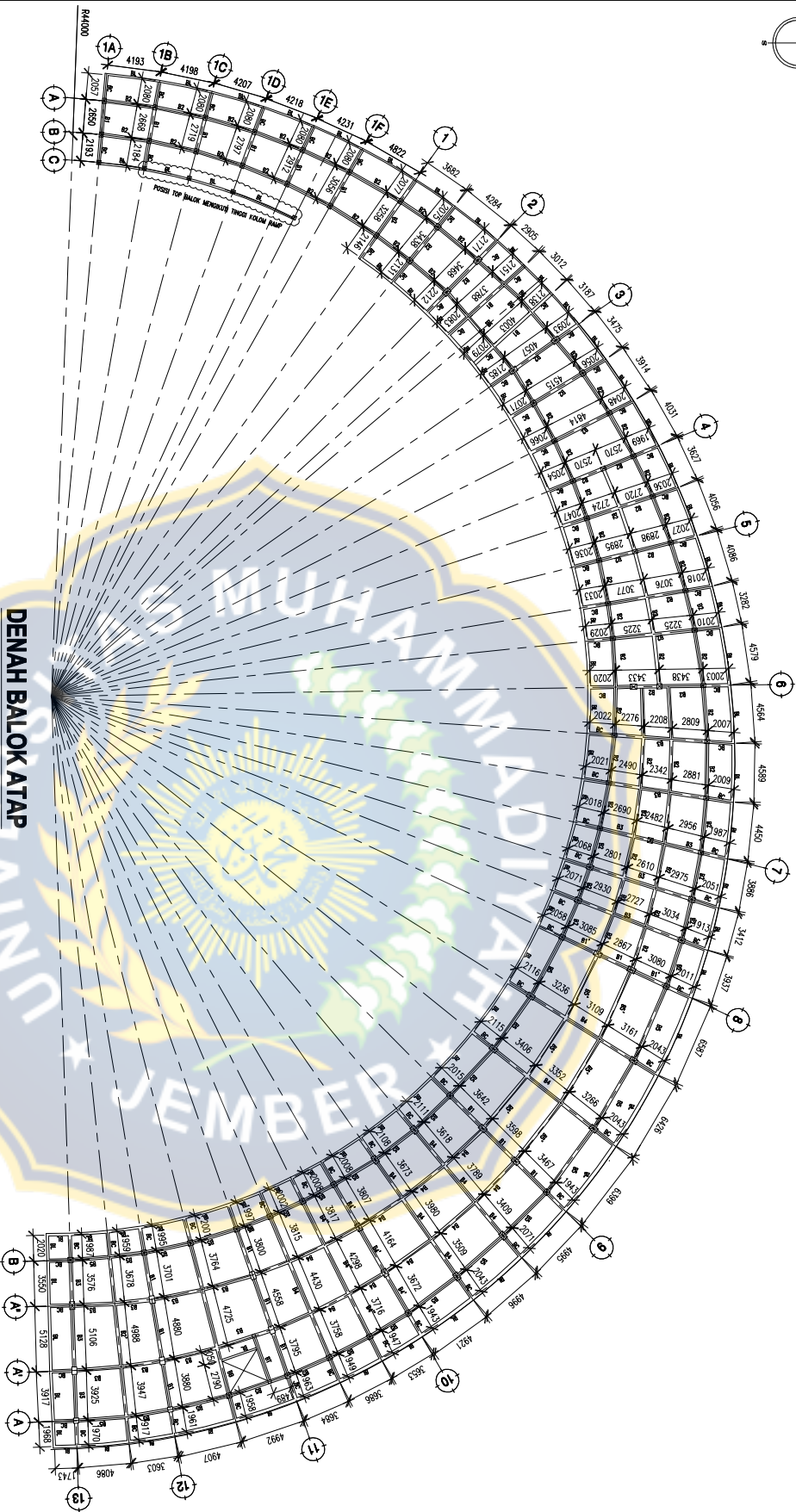

NOTE

CONCRETE QUALITY :

BEAM
 PIECEUP, THE BEAM = K-250
 COLUMN, BEAM, SLAB = K-250
 RESI
 LUM BALOK 40 U40 (BERFORM)
 POLUS BTP 24 U24 (RUM)

REVISION

PROJECT

THE CONSTRUCTION OF INTEGRATED
 LABORATORY AND ADMINISTRATION BUILDING
 AND AUDITORIUM OF THE UNIVERSITY OF JEMBER

PROJECT SUPERVISION CONSULTANT

PT. MUTIARA KAWA - PT. NINDYA KAWA
 (CV)

CONTRACTOR

PT. MUTIARA KAWA - PT. NINDYA KAWA
 (CV)

APPROVED BY: DATE: SIGN:

CHIEF BY: DATE: SIGN:

DRAWN: DATE: SIGN:

SHOP DRAWING

DRAWING GROUP
 TRAINING CENTER

DIVISION
 STRUKTUR

DRAWING TITLE
 DENAH BALOK ATAP

SCALE SHEET DRAWING NO
 1:350 1 4 802.BTR.01.01

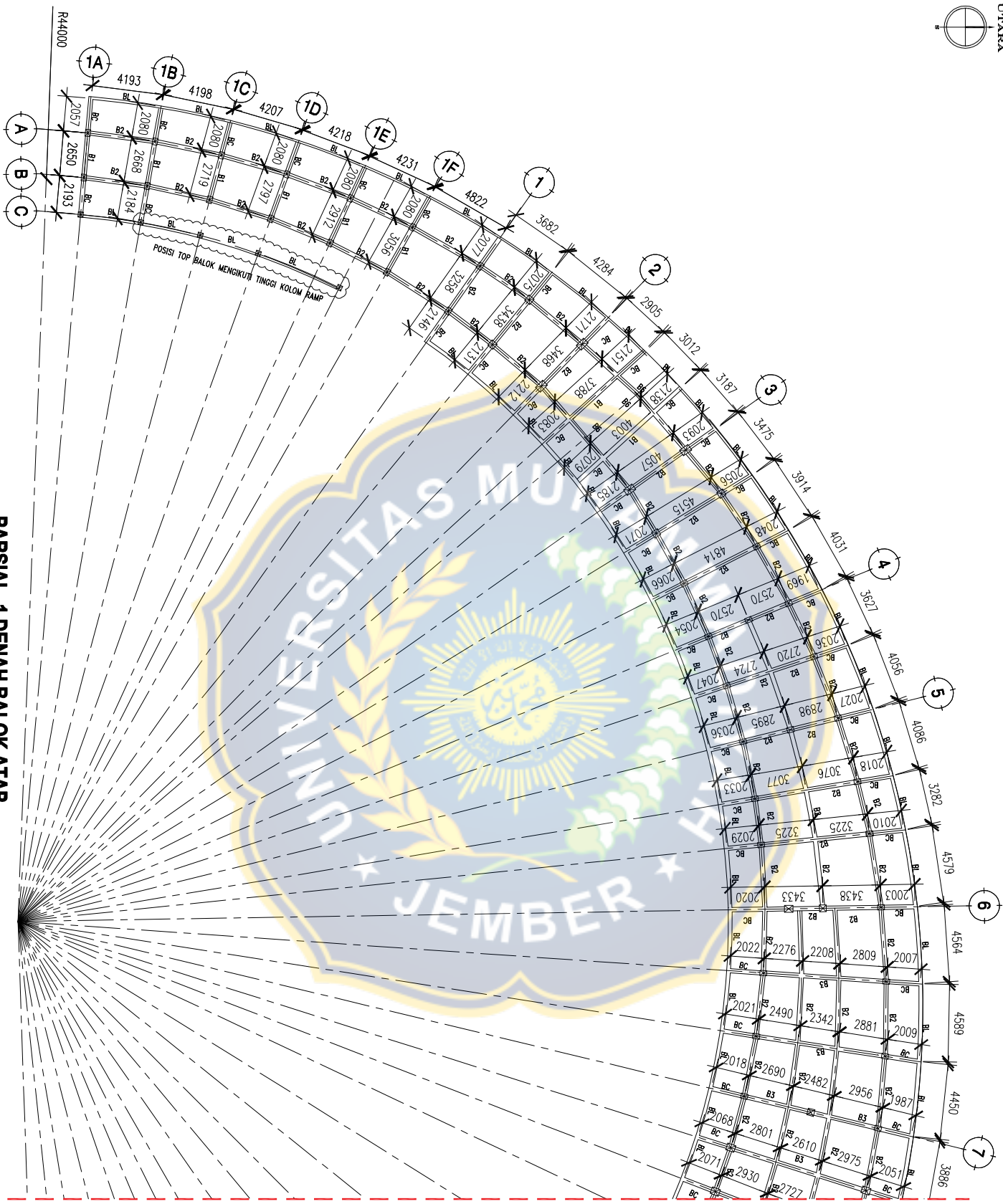

PARSIAL -1 DENAH BALOK ATAP
SKALA 1:220

NOTE

CONCRETE QUANTITY:
 BECON
 PILECAP, THE BEAM = K-250
 COLUMN, BEAM, SLAB = K-250
 REISI
 LUM BUND 40 UPA (DEFROM)
 POUSS BTP 24 UPA (RAM)

REVISION

DATE	REVISION

PROJECT

THE CONSTRUCTION OF INTEGRATED
 LABORATORY FOR THE
 AND AUDITORIUM OF THE UNIVERSITY OF JEMBER

PROJECT SUPERVISION CONSULTANT

PT. MUTIARA KARYA - PT. NINDYA KARYA
 (CV)

CONTRACTOR

PT. MUTIARA KARYA - PT. NINDYA KARYA
 (CV)

APPROVED BY

M. PRADIPONO, ET
 WANDU, ET

CHECKED BY

ANANI TRISNANTO, ET
 TRIA M. WIDYANINGRAT

DRAWN

R. D. M. D.

SHOP DRAWING

DRAWING GROUP
 TRAINING CENTER

DIVISION

STRUKTUR

DRAWING TITLE

PARSIAL -1 DENAH BALOK ATAP

SCALE

1:220

SHEET

2 4

DRAWING NO

8032010101A

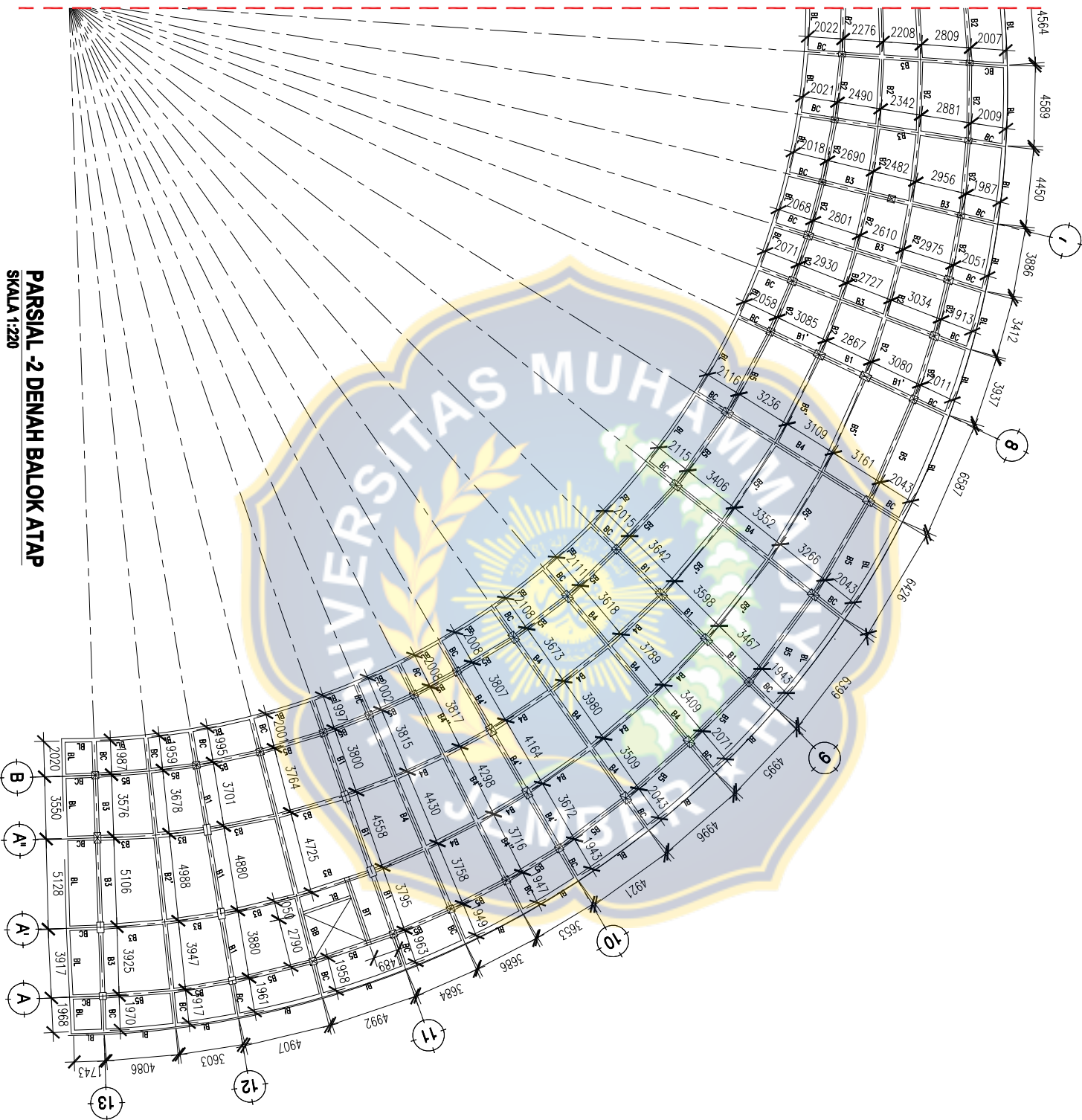

PARSIAL-2 DENAH BALOK ATAP
SKALA 1:220

NOTE

CONCRETE QUANTITY:
 BECON
 PILECAP, THE BEAM = K-250
 COLUMN, BEAM, SLAB = K-250
 BESI
 LUKU BUND 40 UJUK (BERFORM)
 POLUS BHP 24 UJUK (RUM)

DATE	REVISION

PROJECT SUPERVISION CONSULTANT
 THE CONSTRUCTION OF INTEGRATED
 LEARNING CENTER FOR THE
 AND AUDITORIUM OF THE UNIVERSITY OF JEMBER

PT. MUTIARA KARYA - PT. NINDYA KARYA
 (CV)
 APPROVED BY: DATE: SIGN:
 M. PRATIWI
 M. PRATIWI
 M. PRATIWI
 M. PRATIWI

CHANGED BY	DATE	REASON

SHOP DRAWING

DRAWING GROUP
 TRAINING CENTER
 DIVISION
STRUKTUR
 DRAWING TITLE

PARSIAL-2 DENAH BALOK ATAP	
SCALE	1:220
SHEET	3
DRAWING NO	8032010119

TABEL PENJAJANGAN RE-BAR BALOK

TYPE	B1			
	250x400	250x400	250x400	250x400
DIMENSI	TUMBUHAN	LAPANGAN	TUMBUHAN	LAPANGAN
TOP MAIN BAR	5.D16	3.D16	5.D16	3.D16
ROTT MAIN BAR	3.D16	5.D16	3.D16	5.D16
STRIBRUS BAR	D10-100	D10-150	D10-100	D10-100
WIDE BAR	2.D13	2.D13	2.D13	2.D13

TYPE	B4		B4'		B4''	
	400x500	400x500	400x1150	400x1150	400x1100	400x1100
DIMENSI	TUMBUHAN	LAPANGAN	TUMBUHAN	LAPANGAN	TUMBUHAN	LAPANGAN
TOP MAIN BAR	9.D19	6.D19	10.D19	6.D19	10.D19	6.D19
ROTT MAIN BAR	6.D19	9.D19	6.D19	10.D19	6.D19	10.D19
STRIBRUS BAR	D10-100	D10-150	D10-100	D10-150	D10-100	D10-150
WIDE BAR	4.D13	4.D13	4.D13	4.D13	4.D13	4.D13

TYPE	H2		H2'		H2C	
	250x500	250x500	250x500	250x500	250x500	250x500
DIMENSI	TUMBUHAN	LAPANGAN	TUMBUHAN	LAPANGAN	TUMBUHAN	LAPANGAN
TOP MAIN BAR	5.D16	3.D16	5.D16	3.D16	5.D16	3.D16
ROTT MAIN BAR	3.D16	5.D16	3.D16	5.D16	3.D16	5.D16
STRIBRUS BAR	D10-100	D10-150	D10-100	D10-100	D10-100	D10-100
WIDE BAR	2.D13	2.D13	2.D13	-	-	-

TYPE	B4		B4'		B4''	
	400x500	400x500	400x1150	400x1150	400x1100	400x1100
DIMENSI	TUMBUHAN	LAPANGAN	TUMBUHAN	LAPANGAN	TUMBUHAN	LAPANGAN
TOP MAIN BAR	9.D19	6.D19	10.D19	6.D19	10.D19	6.D19
ROTT MAIN BAR	6.D19	9.D19	6.D19	10.D19	6.D19	10.D19
STRIBRUS BAR	D10-100	D10-150	D10-100	D10-150	D10-100	D10-150
WIDE BAR	4.D13	4.D13	4.D13	4.D13	4.D13	4.D13

TYPE	B3			
	350x700	350x700	350x700	350x700
DIMENSI	TUMBUHAN	LAPANGAN	TUMBUHAN	LAPANGAN
TOP MAIN BAR	6.D19	4.D19	8.D19	5.D19
ROTT MAIN BAR	4.D19	6.D19	5.D19	8.D19
STRIBRUS BAR	D10-100	D10-150	D10-100	D10-150
WIDE BAR	2.D13	2.D13	2.D13	2.D13

TYPE	B5		B5'		B5''	
	300x500	300x500	300x500	300x500	250x500	250x500
DIMENSI	TUMBUHAN	LAPANGAN	TUMBUHAN	LAPANGAN	TUMBUHAN	LAPANGAN
TOP MAIN BAR	7.D16	4.D16	6.D16	3.D16	7.D16	4.D16
ROTT MAIN BAR	4.D16	7.D16	3.D16	6.D16	4.D16	7.D16
STRIBRUS BAR	D10-100	D10-150	D10-100	D10-150	D10-100	D10-150
WIDE BAR	-	-	-	-	2.D13	2.D13

NOTE

CONCRETE QUANTITY
 BECON
 PILECAP, THE BEAM = K-250
 COLUMN, BEAM, SLAB = K-250
 RESI
 LULU BILD 40 (DEFORM)
 POLUS BHP 24 U24 (RAM)

DATE	REVISION

PROJECT SUPERVISION CONSULTANT
 PT. HUTAJAYA KARYA - PT. NINDYA KARYA (JV)
 ENGINEER: DR. HENDRIK SUGENAWA, VITA PERISA
 ARCHITECT: DR. HENDRIK SUGENAWA, VITA PERISA

CONTRACTOR
 APPROVED BY: DATE: SIGN:
 M. PRANANTO, ET
 W. HANIK, ET
 CHECKED BY: DATE: SIGN:
 A. HANIK, ET
 T. HANIK, ET
 DRAWN: DATE: SIGN:
 R. D. M. D.

SHOP DRAWING
 DRAWING GROUP
 TRAINING CENTER
 DIVISION
STRUKTUR
 DRAWING TITLE

BAR SCHEDULE
 SCALE SHEET DRAWING NO
 1:200 4 4 S03M01A11C

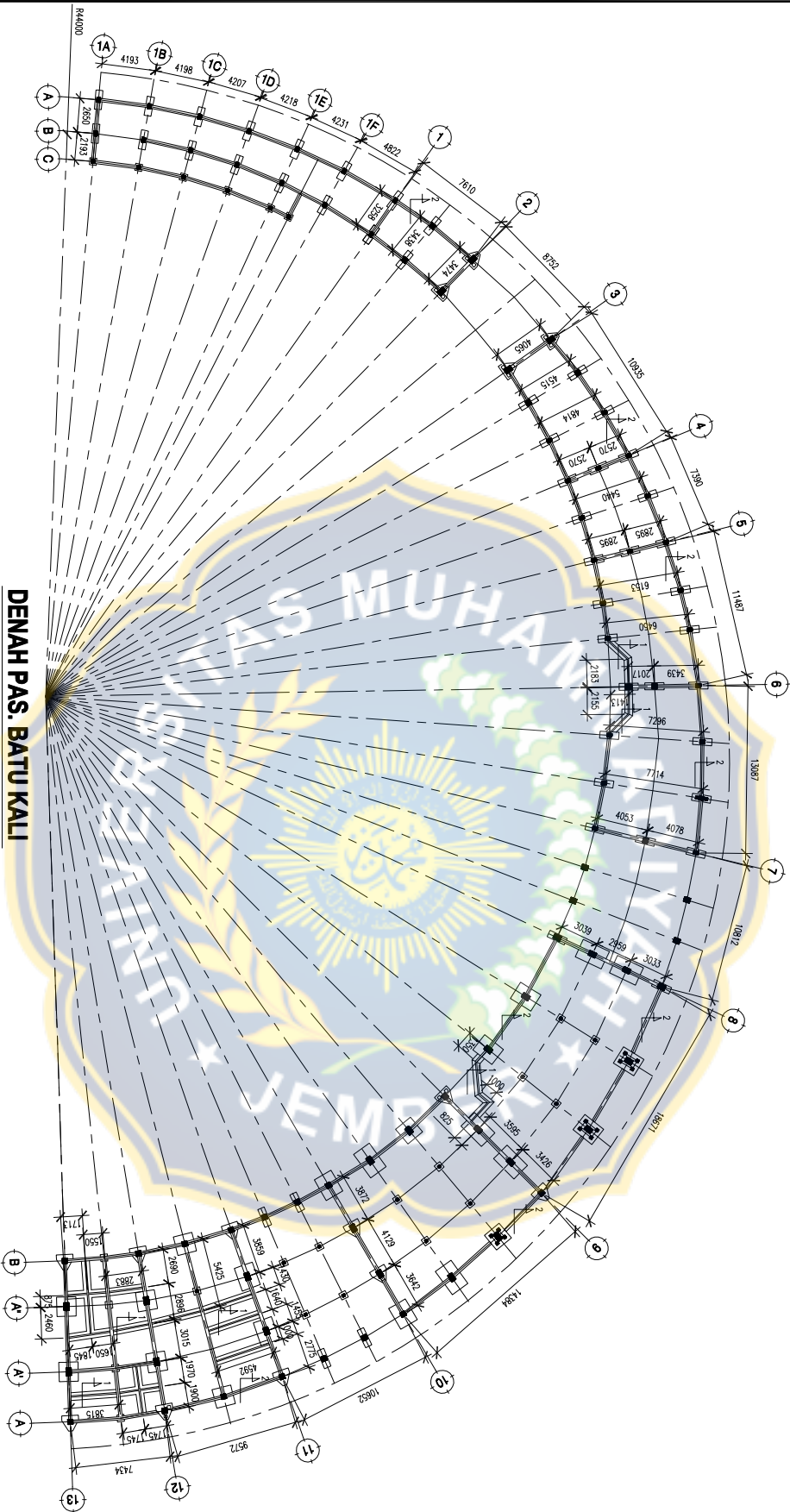

DENAH PAS. BATUKALI
SKALA 1:350

NOTE

CONCRETE QUANTITY :

BECON
 PIECEUP THE BEAM = K-250
 COLUMN, BEAM, SLAB = K-250
 BESI
 LUKU BAJU 40 UAH (BERFORM)
 POLUS BTP 24 U24 (RUM)

REVISION

DATE	REVISION

PROJECT

THE CONSTRUCTION OF INTEGRATED
 LEARNING CENTER FOR THE
 AND AUDITORIUM OF THE UNIVERSITY OF JEMBER

PROJECT SUPERVISION CONSULTANT

PT. MUTIARA KARYA - PT. NINDYA KARYA
 (CV)

CONTRACTOR

PT. MUTIARA KARYA - PT. NINDYA KARYA
 (CV)

APPROVED BY: DATE: SIGN:

CHANGED BY: DATE: SIGN:

DRAWN: DATE: SIGN:

SHOP DRAWING

DRAWING GROUP
 TRAINING CENTER
 DIVISION
STRUKTUR

DRAWING TITLE
 DENAH PAS. BATUKALI

SCALE	SHEET	DRAWING NO
1:350	1	02.STRUK.014

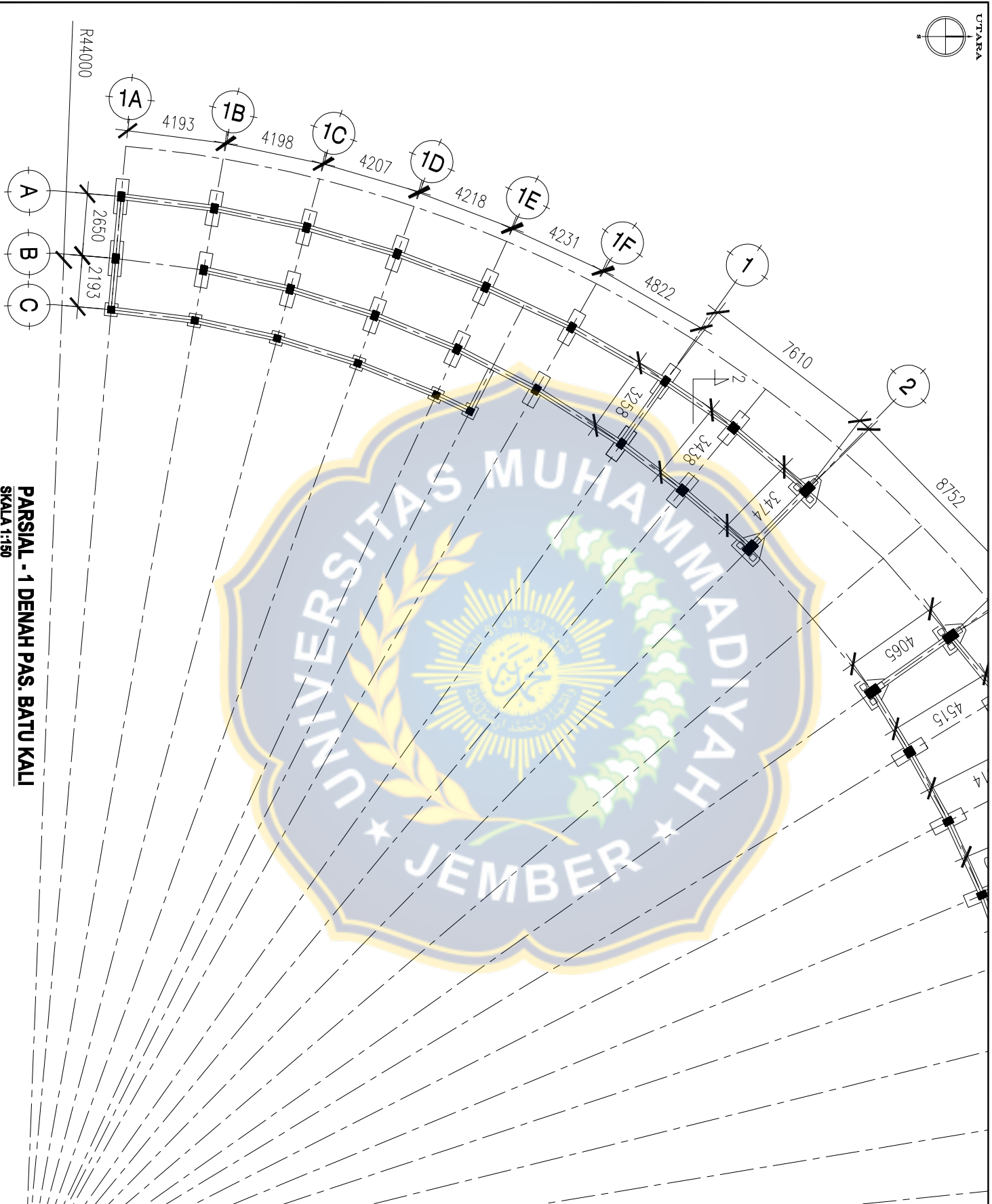

NOTE

CONCRETE QUANTITY:

BELOW
 PIECEUP THE BEAM = K-250
 COLUMN, BEAM, SLAB = K-250
 REISI
 LUKU BILD 40 UMB (GEBOW)
 POLUS BHP 24 U24 (RUM)

REVISION

DATE	REVISION

PROJECT

THE CONSTRUCTION OF INTEGRATED
 LABORATORY AND TRAINING CENTER
 AND AUDITORIUM OF THE UNIVERSITY OF JEMBER

PROJECT SUPERVISION CONSULTANT

PT. MUTIARA KARYA - PT. NINDYA KARYA (CV)

CONTRACTOR

PT. MUTIARA KARYA - PT. NINDYA KARYA (CV)

APPROVED BY: DATE: SIGN:

M. PRATIWI
 MANAGER

CHIEF BY: DATE: SIGN:

AGUNG TRISNANTO, ST
 TRAJA MURTIWALAYAT

DRAWING: DATE: SIGN:

R. D. M. D.

SHOP DRAWING

DRAWING GROUP
 TRAINING CENTER
 DIVISION
STRUKTUR
 DRAWING TITLE

PARSIAL - 1 DENAH PAS. BATU KALI

SCALE SHEET DRAWING NO
 1:150 2 6 8323010104

PARSIAL - 1 DENAH PAS. BATU KALI
 SKALA 1:150

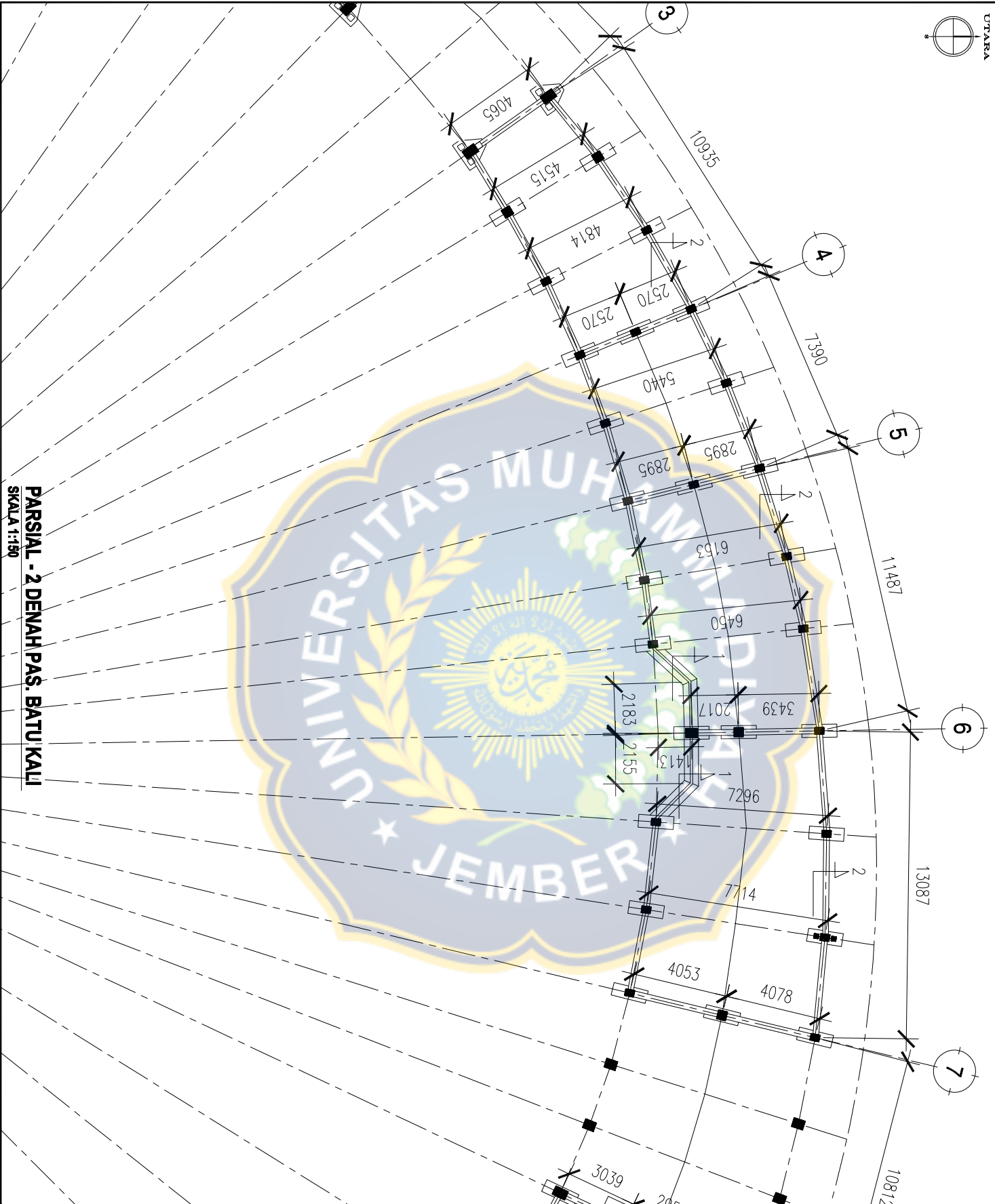

PARSIAL - 2 DENAH PAS. BATUKALI
SKALA 1:150

NOTE

CONCRETE QUANTITY :

BELOW
 RECAP, THE BEAM = K-250
 COLUMN, BEAM, SLAB = K-250
 REISI
 LUKA BIRD 40 UAG (OVERLOW)
 POLUS BTP 24 U24 (RAIN)

REVISION

DATE PROJECT

THE CONSTRUCTION OF INTEGRATED
 LABORATORY BUILDING FOR THE
 AND ADMINISTRATION OF THE UNIVERSITY OF JEMBER

PROJECT SUPERVISION CONSULTANT

PT. MUTIARA KARYA - PT. NINDYA KARYA
 (CV)

CONTRACTOR

CONTRACTOR

APPROVED BY DATE SIGN

APPROVED BY DATE SIGN

APPROVED BY DATE SIGN

APPROVED BY DATE SIGN

APPROVED BY DATE SIGN

APPROVED BY DATE SIGN

APPROVED BY DATE SIGN

APPROVED BY DATE SIGN

APPROVED BY DATE SIGN

SHOP DRAWING

DRAWING GROUP
 TRAINING CENTER

STRUKTUR

DRAWING TITLE

PARSIAL 2 DENAH PAS. BATUKALI

SCALE SHEET DRAWING NO

1:150 3 6 8032014/148

UTARA

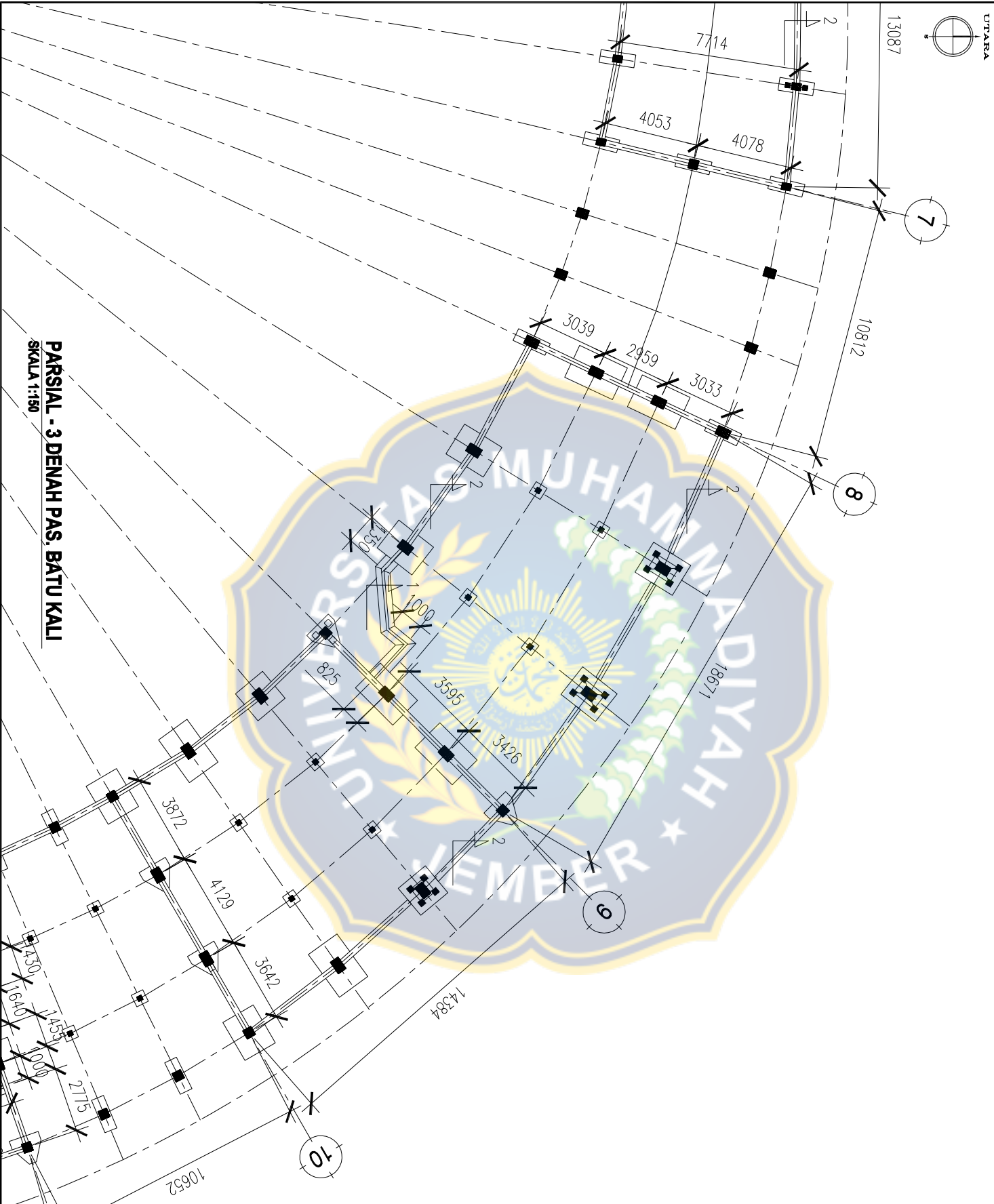

PARSIAL - 3 DENAH PAS. BATU KALI
SKALA 1:150

NOTE

CONCRETE QUANTITY :

BECON
 PIECEUP THE BEAM = K-250
 COLUMN, BEAM, SLAB = K-250
 BESI
 LUKU BILD 40 UAH (BERFORM)
 POLUS BHP 24 U24 (RUM)

DATE	REVISION

THE CONSTRUCTION OF INTEGRATED
 LAMPUNG UNIVERSITY OF TECHNOLOGY
 AND AGRICULTURE OF THE UNIVERSITY OF LAMPUNG

PROJECT SUPERVISION CONSULTANT

ENGINEER/ARCHITECT/STRUCTURAL ENGINEER
 PT. HUTAJAYA KARYA - PT. NINDYA KARYA
 (CV)

TEAM LEADER	DATE	SIKSI

APPROVED BY	DATE	SIKSI

CHARGE BY	DATE	SIKSI

DRAWING	DATE	SIKSI

SHOP DRAWING

DRAWING GROUP
 TRAINING CENTER
 DIVISION
STRUKTUR
 DRAWING TITLE

SCALE	SHEET	DRAWING NO
1:150	4	8

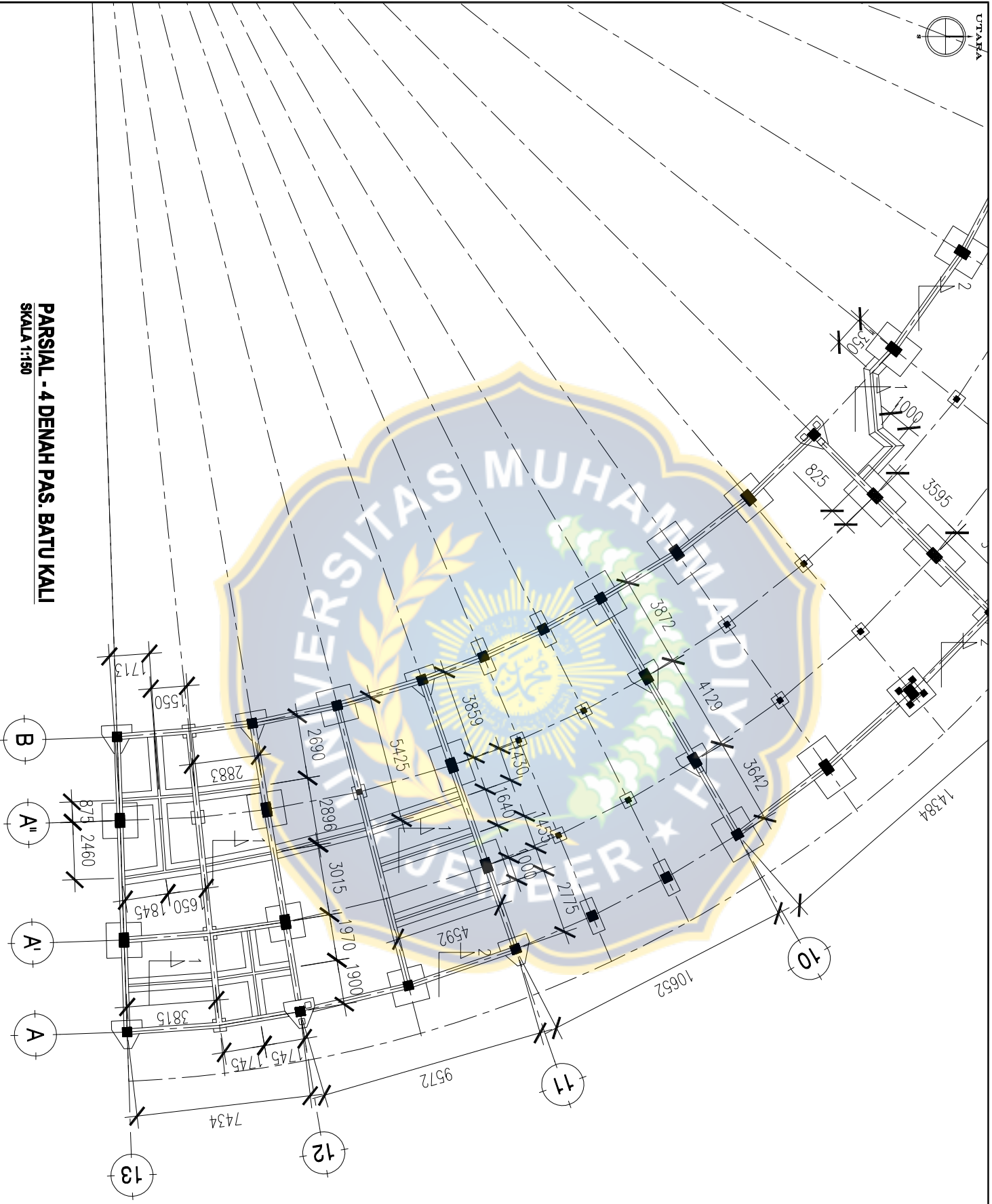

PARSIAL - 4 DENAH PAS, BATU KALI
SKALA 1:150

NOTE

CONCRETE QUANTITY:
 BECON
 PILECAP, THE BEAM = K-250
 COLUMN, BEAM, SLAB = K-250
 BESI
 LUKER BUND 40 UJUK (BEFORM)
 POLUS BTP 24 U24 (RUBI)

REVISION

DATE	REVISION

PROJECT

THE CONSTRUCTION OF INTEGRATED
 LABORATORY BUILDING FOR THE
 AND ACADEMICAL OF THE UNIVERSITY OF JEMBER

PROJECT SUPERVISION CONSULTANT

PT. MUTIARA KARYA - PT. NINDYA KARYA
 (CV)

TEAM LEADER	DATE	SIKSI

APPROVED BY	DATE	SIKSI

CHIEF BY	DATE	SIKSI

DRAWN	DATE	SIKSI

SHOP DRAWING

DRAWING GROUP
 TRAINING CENTER
 DIVISION
STRUKTUR
 DRAWING TITLE

SCALE	SHEET	DRAWING NO
1:150	8	80370114140

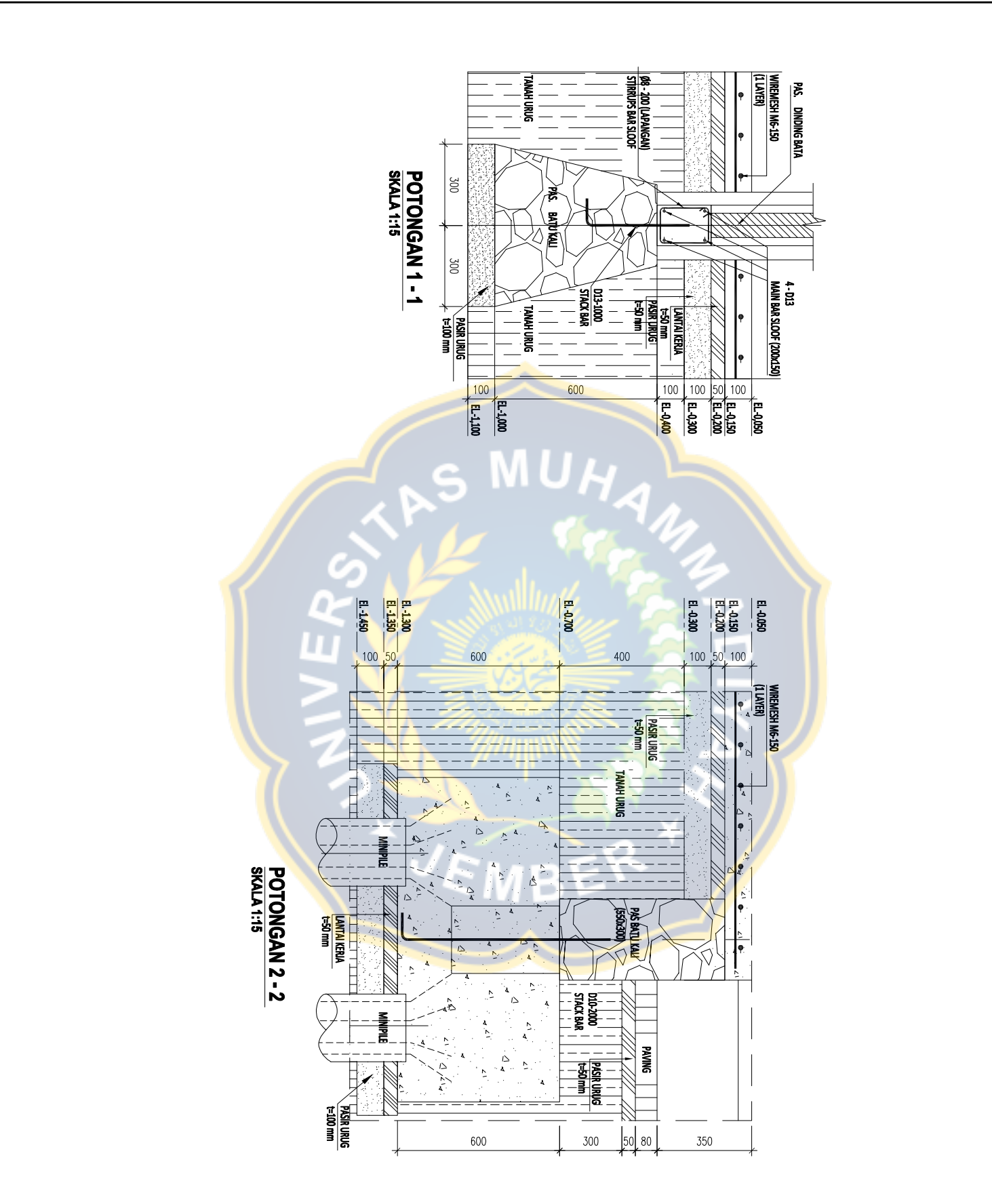

POTONGAN 1 - 1
SKALA 1:15

POTONGAN 2 - 2
SKALA 1:15

NOTE

CONCRETE QUALITY :

BECON
PIECAP, THE BEAM = K-250
COLUMN, BEAM, SLAB = K-230

RESI
LINK BIRD 40 U40 (BERFORM)
POLUS BTP 24 U24 (RUB)

DATE	REVISION

PROJECT

THE CONSTRUCTION OF INTEGRATED LABORATORY AND ADMINISTRATION OF THE UNIVERSITY OF JEMBER

PROJECT SUPERVISION CONSULTANT

PT. HUTAJAYA KARYA - PT. NINDYA KARYA (CV)

TEAM LEADER	DATE	SIGN

CONTRACTOR

APPROVED BY	DATE	SIGN

SHOP DRAWING

DRAWING GROUP
TRAINING CENTER

DIVISION
STRUKTUR

DRAWING TITLE

SCALE	SHEET	DRAWING NO
1:15	8	8

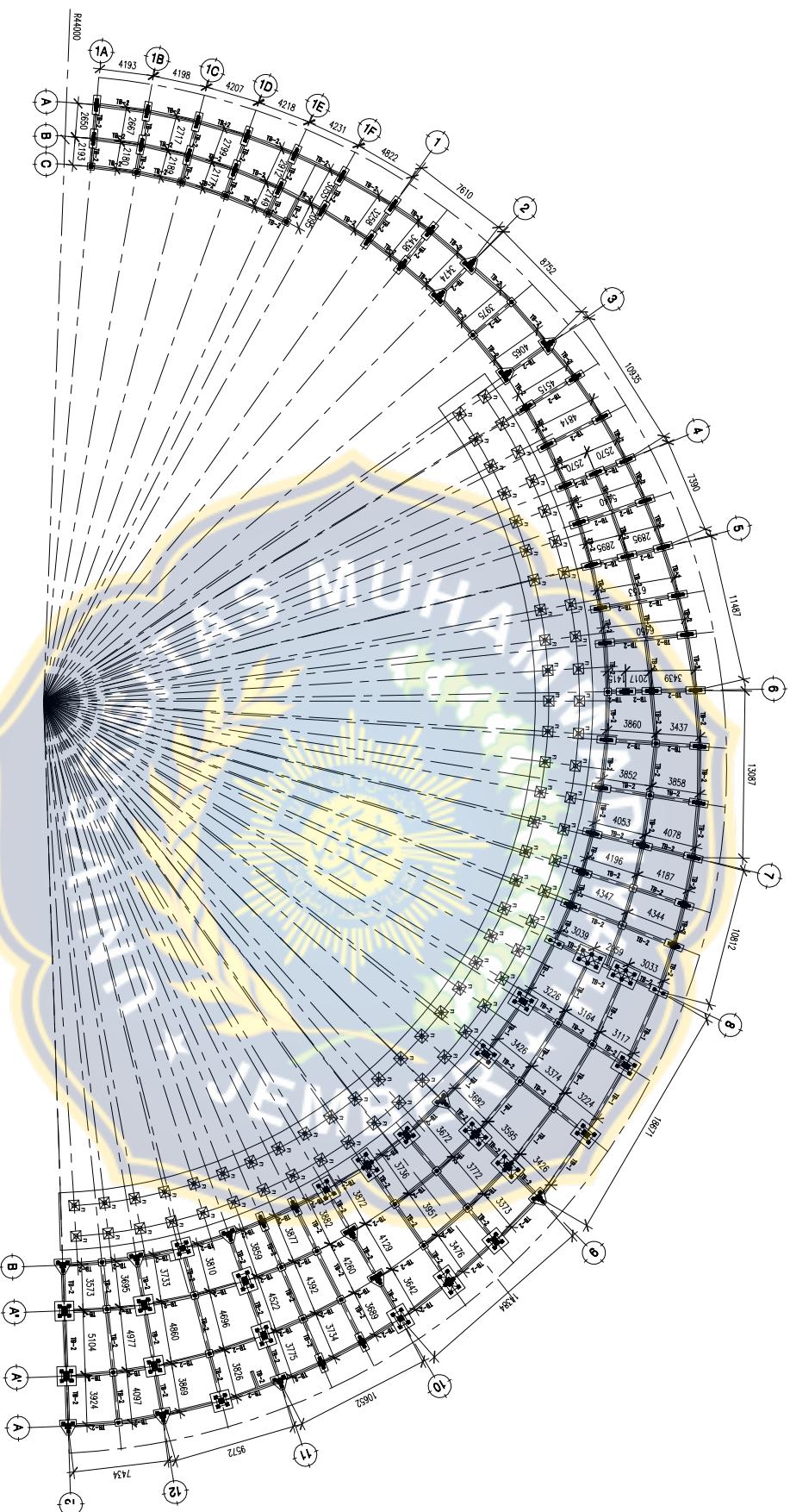

LAY-OUT POSISI KANOP
SKALA 1:350

NOTE

CONCRETE QUANTITY :

- BECON
- PIECAP, THE BEAM = K-250
- COLUMN, BEAM, SLAB = K-250
- RESI
- LINK BILD 40 UMB (BEFON)
- POLOS BTP 24 U24 (RUM)

REVISION

DATE	REVISION

PROJECT

THE CONSTRUCTION OF INTEGRATED
 LAMPUNG UNIVERSITY OF TECHNOLOGY
 AND ACADEMY OF THE UNIVERSITY OF LAMPUNG

PROJECT SUPERVISION CONSULTANT

PT. MUTIARA KARYA - PT. NINDYA KARYA
 (CV)

CONTRACTOR

PT. MUTIARA KARYA - PT. NINDYA KARYA
 (CV)

APPROVED BY :

M. PRADIPONO, ET
 W. HENDRI, ET

CHIEF BY :

AMANI TRISNANTI, ET
 TRIA M. W. W. K. A. ET

DRAWING

R. D. M. D.
 SKALA

SHOP DRAWING

DRAWING GROUP
 TRAINING CENTER
DIVISION
STRUKTUR

DRAWING TITLE

LAY-OUT POSISI KANOP

SCALE	SHEET	DRAWING NO
1:350	1	SO.STRUK.009

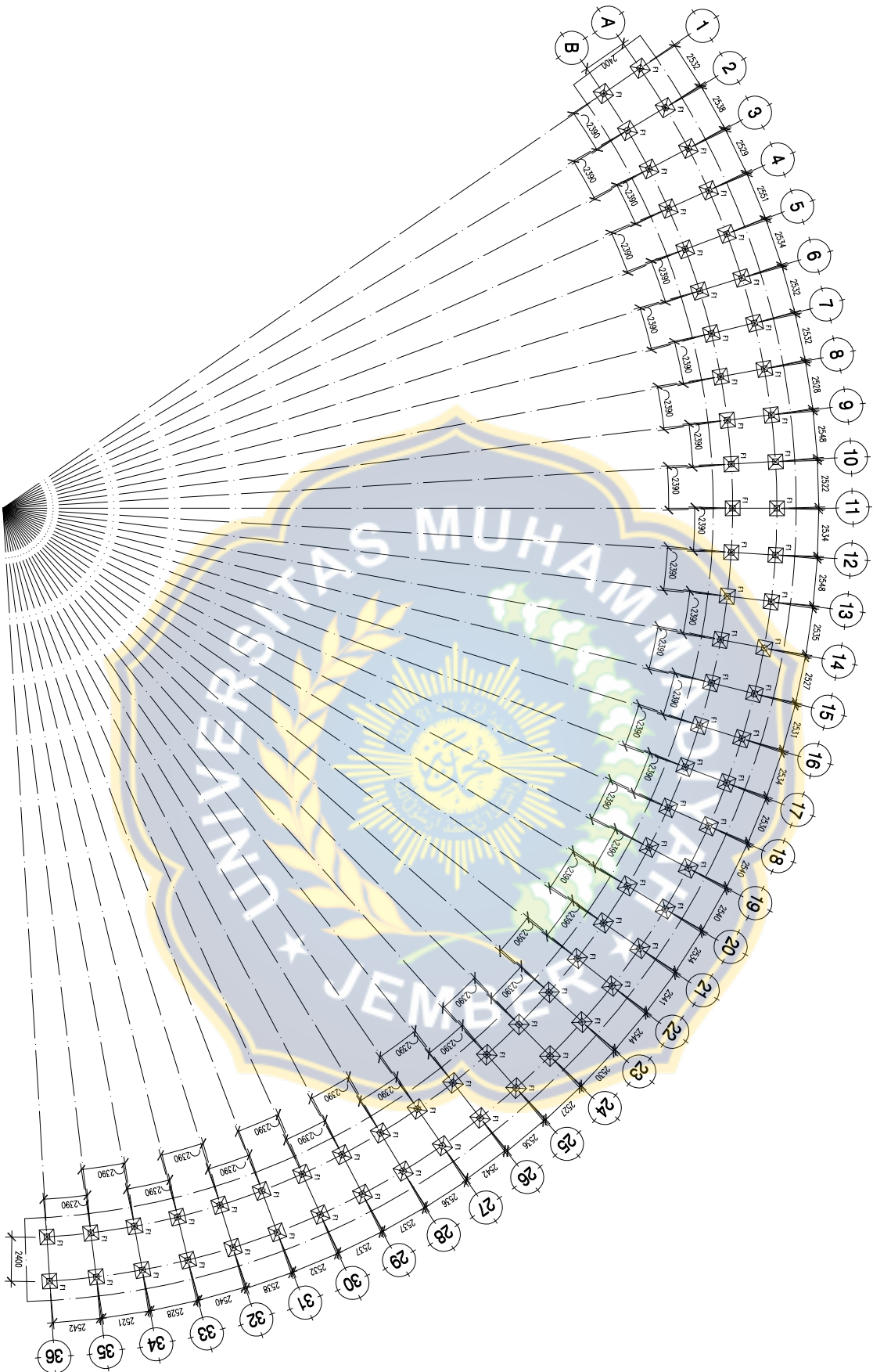

DENAH FOOTPLATE KANOPI
SKALA 1:220

NOTE

CONCRETE QUALITY :
 BECON
 R/C/CAP, THE BEAM = K-250
 COLUMN, BEAM, SLAB = K-230
 RESI
 LUKU BILD 40 U40 (DEFORM)
 POLUS BHP 24 U24 (RUM)

DATE	REVISION

PROJECT
 THE CONSTRUCTION OF INTEGRATED
 LAMPUNG UNIVERSITY OF TECHNOLOGY
 AND AGRICULTURE OF THE UNIVERSITY OF JEMBER
 PROJECT SUPERVISION CONSULTANT

TEAM LEADER
 DATE
 SIGN
 ENGINEER/ARCHITECT
 CONTRACTOR

APPROVED BY
 DATE
 SIGN
 M. PRADHONO, ST
 W. HADIPRASETIO, ST

CHECKED BY
 DATE
 SIGN
 ANAM TIRTOHADI, ST
 TRIA M. WIDYANINGRAT

DRAWN
 DATE
 SIGN
 R. D. M. D.
 DWANITA

SHOP DRAWING
 DRAWING GROUP
 TRAINING CENTER
 DIVISION
STRUKTUR
 DRAWING TITLE
 DENAH FOOTPLATE KANOPI
 SCALE
 SHEET 2 4
 DRAWING NO
 1:220 2023/01/04

DETAIL FOOTPLATE F1, Qty = 72 UNIT

KEY-PLAN

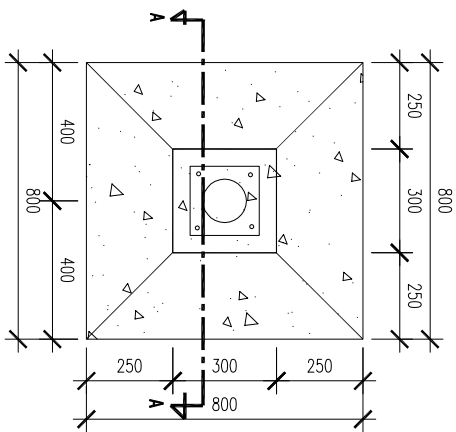

LAY-OUT F1
SKALA 1:15

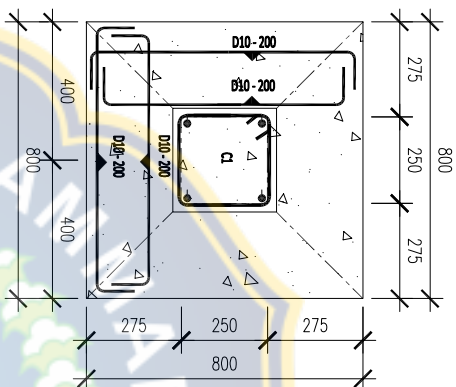

RE-BAR F1
SKALA 1:15

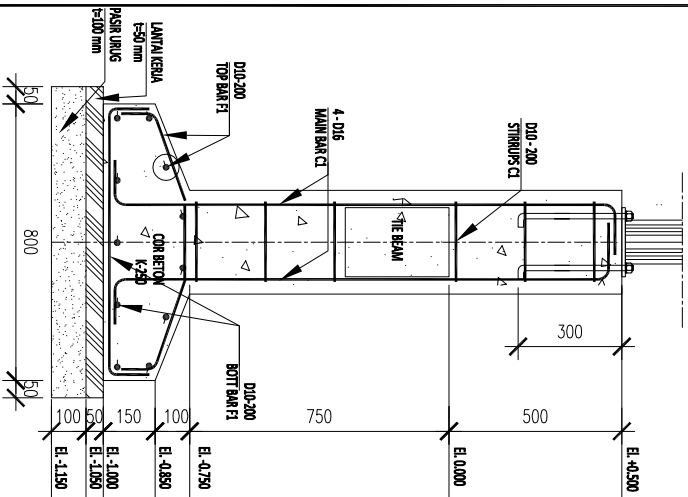
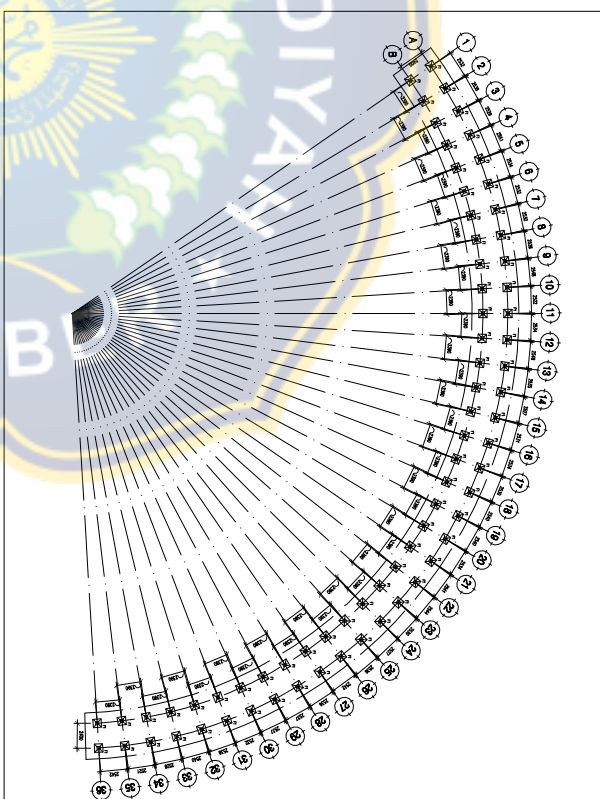

POTONGAN A - A
SKALA 1:15

DETAIL POSISI ANCHOR
SKALA 1:15

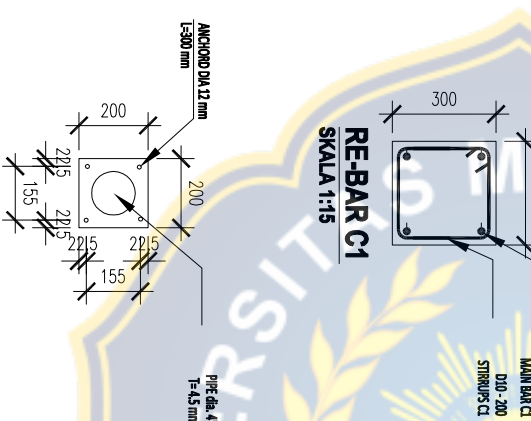

RE-BAR C1
SKALA 1:15

NOTE

CONCRETE QUANTITY:
 BECON
 PIECEUP THE BEAM = K-250
 COLUMN, BEAM, SLAB = K-250
 RESI
 LUBR BLD 40 UHQ (BEROM)
 POLS BTP 24 U24 (RM)

DATE	REVISION

THE CONSTRUCTION OF INTEGRATED LAMPUNG UNIVERSITY OF ENGINEERING AND TECHNOLOGY OF THE UNIVERSITY OF JEMBER

PROJECT SUPERVISION CONSULTANT

PT. HUTAJAYA KARYA - PT. NINDYA KARYA (CV)

TEAM LEADER	DATE	SIKSH

APPROVED BY	DATE	SIKSH

CHECKED BY	DATE	SIKSH

DRAWN	DATE	SIKSH

SHOP DRAWING

DRAWING GROUP
 TRAINING CENTER
 DIVISION
STRUKTUR

DRAWING TITLE
 DETAIL FOOTPLATE

SCALE	SHEET	DRAWING NO
1:300	3	8030701.0088

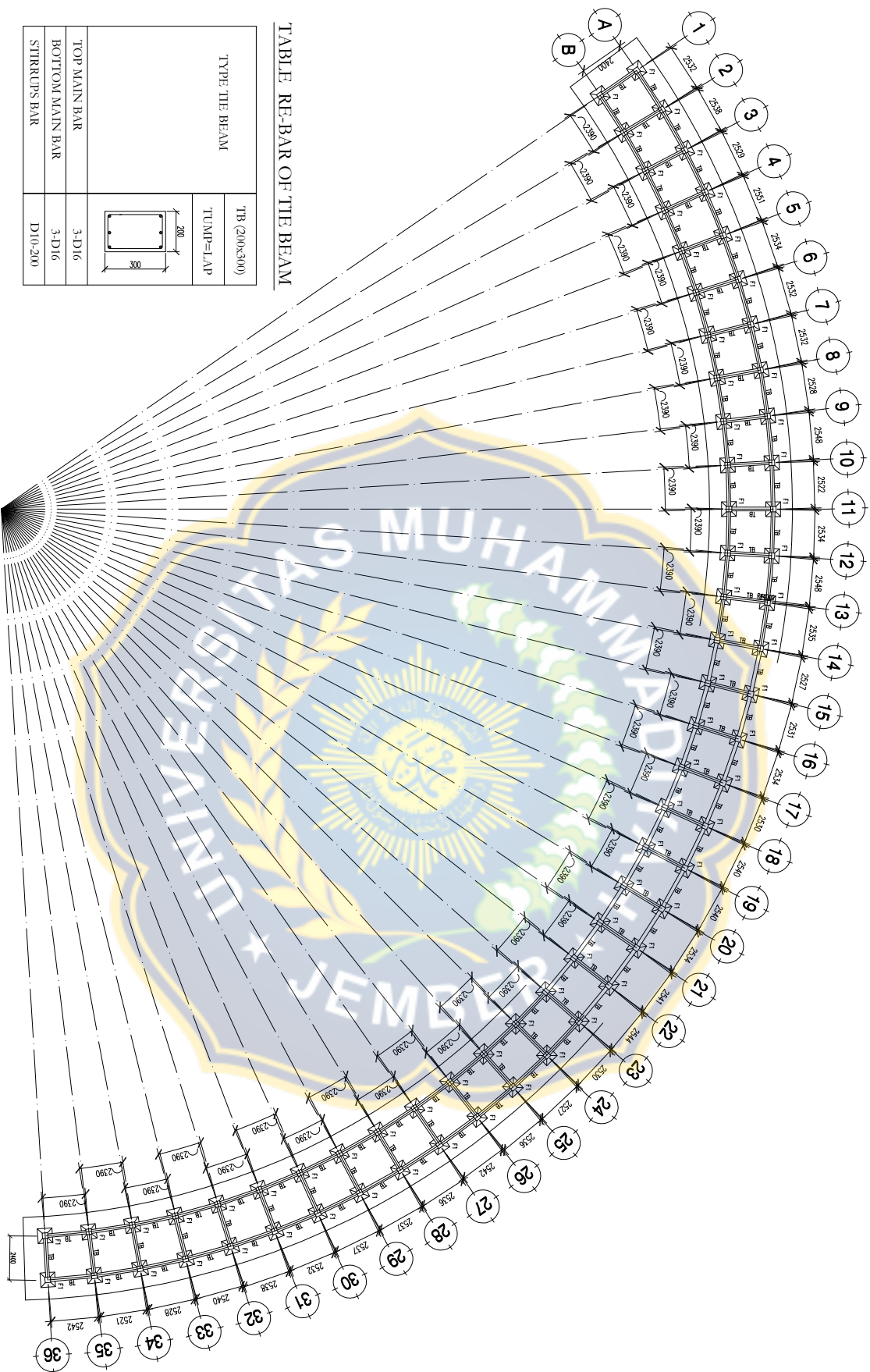

TABLE RE-BAR OF THE BEAM

TYPE THE BEAM	TB (200x300)
	TUMP=1AP
TOP MAIN BAR	3-D16
BOTTOM MAIN BAR	3-D16
STIRRUPS BAR	D10-200

DENAH TIE BEAM KANOPI
SKALA 1:220

NOTE

CONCRETE QUALITY :
 BERTON
 PILECAP, TIE BEAM = K-250
 COLUMN, BEAM, SLAB = K-250
 BESI
 LUKU BILD 40 U40 (BERFORM)
 POLUS BIP 24 U24 (RUM)

REVISION

DATE PROJECT

THE CONSTRUCTION OF INTEGRATED
 LAMPUNG UNIVERSITY OF ENGINEERING
 AND TECHNOLOGY OF THE UNIVERSITY OF JAMBER

PROJECT SUPERVISION CONSULTANT

PT. HUTAJAYA KARYA - PT. NINDYA KARYA
 (CV)

CONTRACTOR

PT. HUTAJAYA KARYA - PT. NINDYA KARYA
 (CV)

APPROVED BY DATE SIGN

M. PRATIWI, I.T

W. HANIK, I.T

CHIEF BY DATE SIGN

AMANI, I.T

THEA, I.T

DRAWN DATE SIGN

R.O.M.O

SHOP DRAWING

DRAWING GROUP
 TRAINING CENTER

STRUKTUR

DRAWING TITLE

DENAH TIE BEAM KANOPI

SCALE SHEET DRAWING NO
 1:220 4 4 S03TPO1.006C

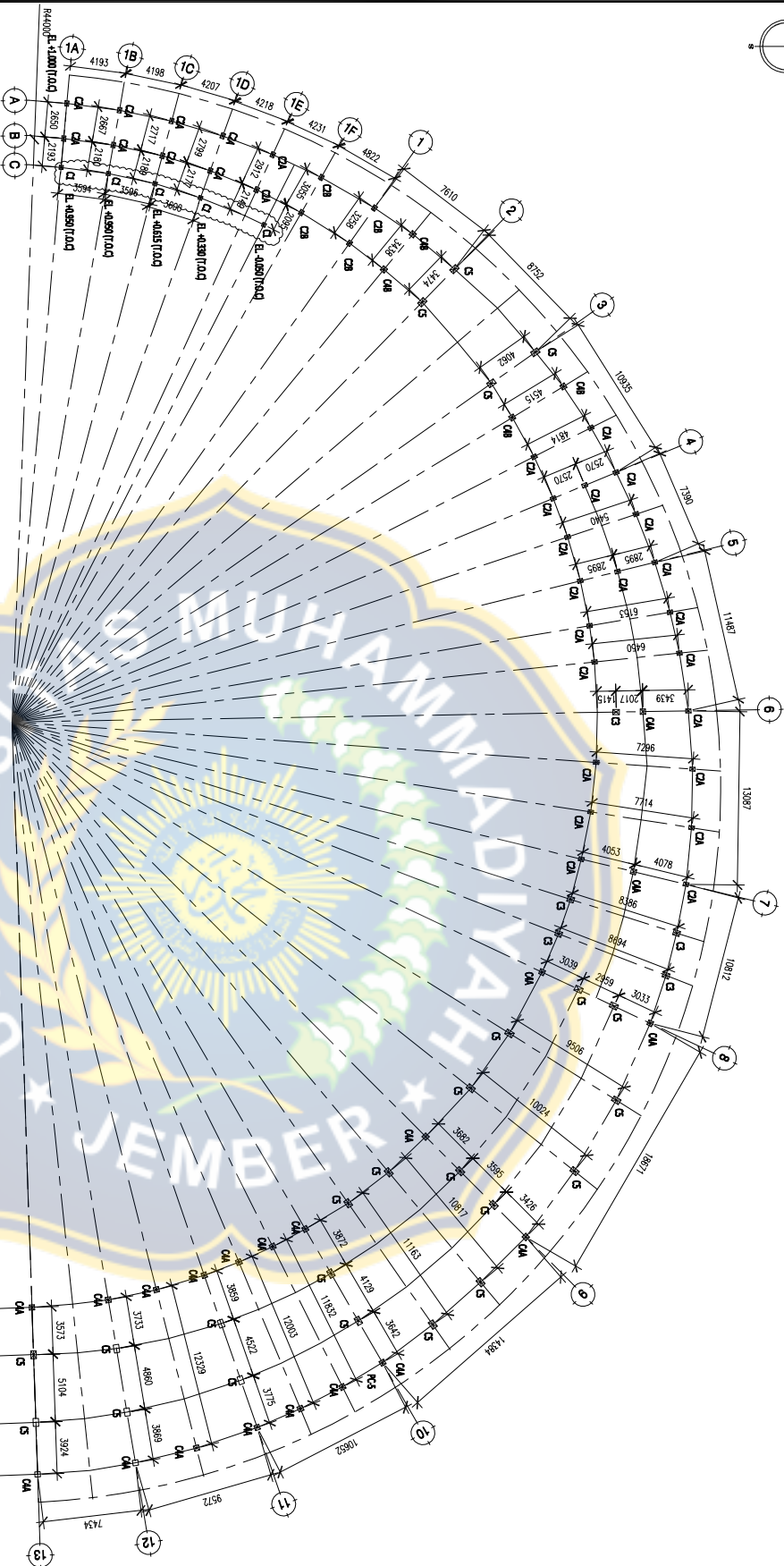

DENAH KOLOM LANTAI 1
SKALA 1:350

TABEL PENUNJANG KOLOM

DIMENSI	Tipe Kolom							
	C1	C2A	C2B	C3	C4A1T1	C4A1T2	C4B	C5
300 X 300								
MAIN BARS	6-D16	10-D16	12-D16	12-D16	10-D16	8-D16	16-D16	14-D19
STRENGTH	D10-200	D10-150	D10-150	D10-100	D10-100	D10-100	D10-100	D10-100

NOTE

CONCRETE QUANTITY:
 BECON
 PILECAP, THE BEAM = K-250
 COLUMN, BEAM, SLAB = K-250
 BESI
 LUKA BUD 40 UAH (BEKON)
 POLUS BHP 24 U24 (RUM)

REVISION

DATE PROJECT



PROJECT SUPERVISION CONSULTANT

ENGINEER'S NAME AND ADDRESS OF THE UNIVERSITY OF LABOR

CONTRACTOR

APPROVED BY DATE SIGN

MANAGER DATE SIGN

CHECKED BY DATE SIGN

DATE SIGN

DRAWING NO

DATE SIGN

SHOP DRAWING

DRAWING GROUP
 TRAINING CENTER
 DIVISION
STRUKTUR
 DRAWING TITLE
 DENAH KOLOM LANTAI 1

SCALE SHEET DRAWING NO
 1:350 1 4 802.BHP.1.008

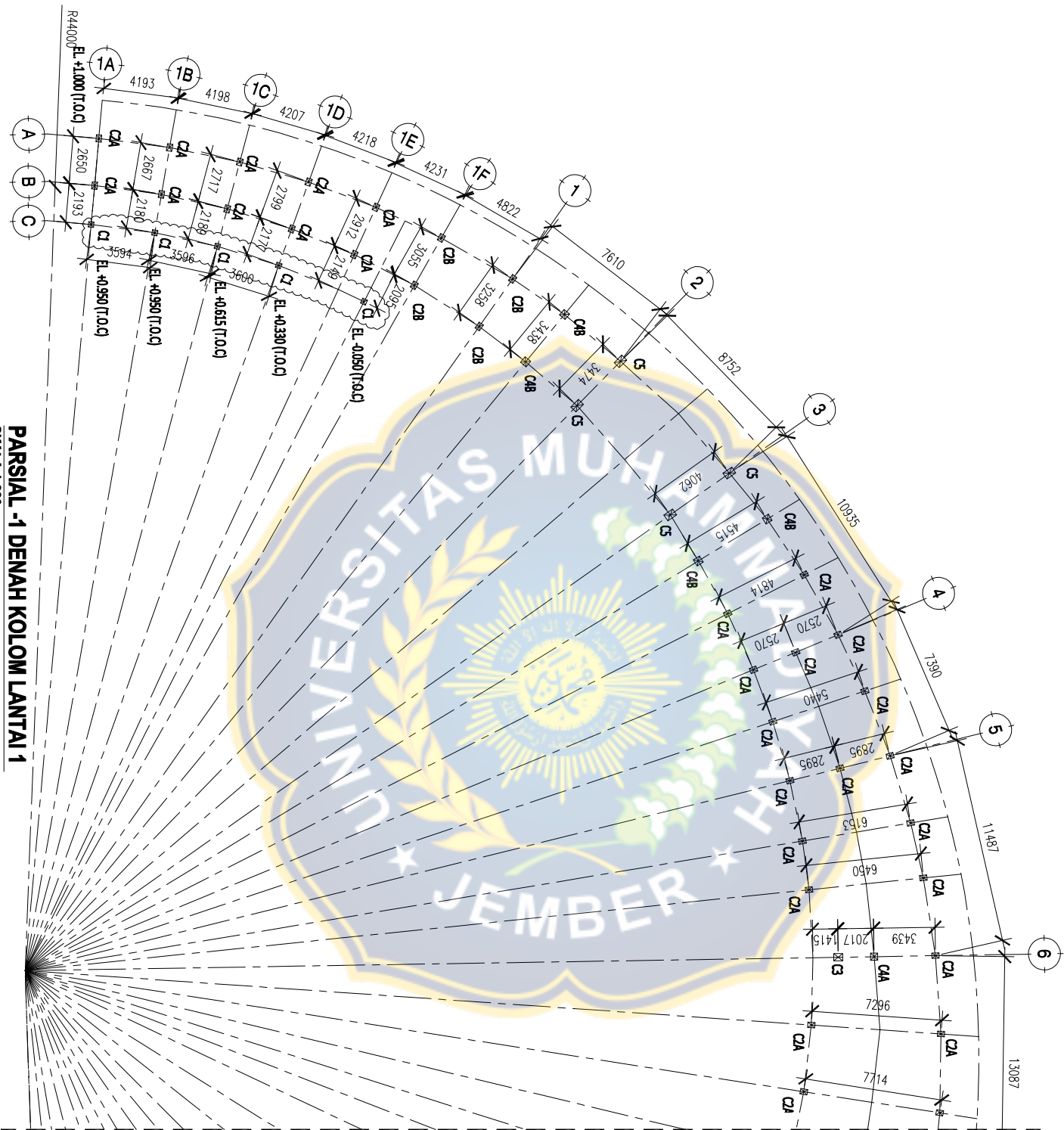

PARSIAL -1 DENAH KOLOM LANTAI 1
 SKALA 1:220

NOTE

CONCRETE QUANTITY:
 BECON
 RECAP, THE BEAM = K-250
 COLUMN, BEAM, SLAB = K-250
 RESI
 LUKU BUND 40 UMB (BERFORM)
 POUSS BTP 24 U24 (RUM)

REVISION

DATE	REVISION

PROJECT

THE CONSTRUCTION OF INTEGRATED
 LAMPUNG UNIVERSITY OF TECHNOLOGY
 AND ACADEMIA OF THE UNIVERSITY OF JEMBER

PROJECT SUPERVISION CONSULTANT

PT. HUTAJAYA KARYA - PT. NINDYA KARYA
 (CV)

CONTRACTOR

PT. HUTAJAYA KARYA - PT. NINDYA KARYA
 (CV)

APPROVED BY

DATE	SIKSI
DATE	SIKSI
DATE	SIKSI

CHANGED BY

DATE	SIKSI
DATE	SIKSI
DATE	SIKSI

SHOP DRAWING

DRAWING GROUP
 TRAINING CENTER
 DIVISION
STRUKTUR
 DRAWING TITLE

PARSIAL -1 DENAH KOLOM LANTAI 1		
SCALE	2	4
SHEET	2	4
DRAWING NO		
1:220		

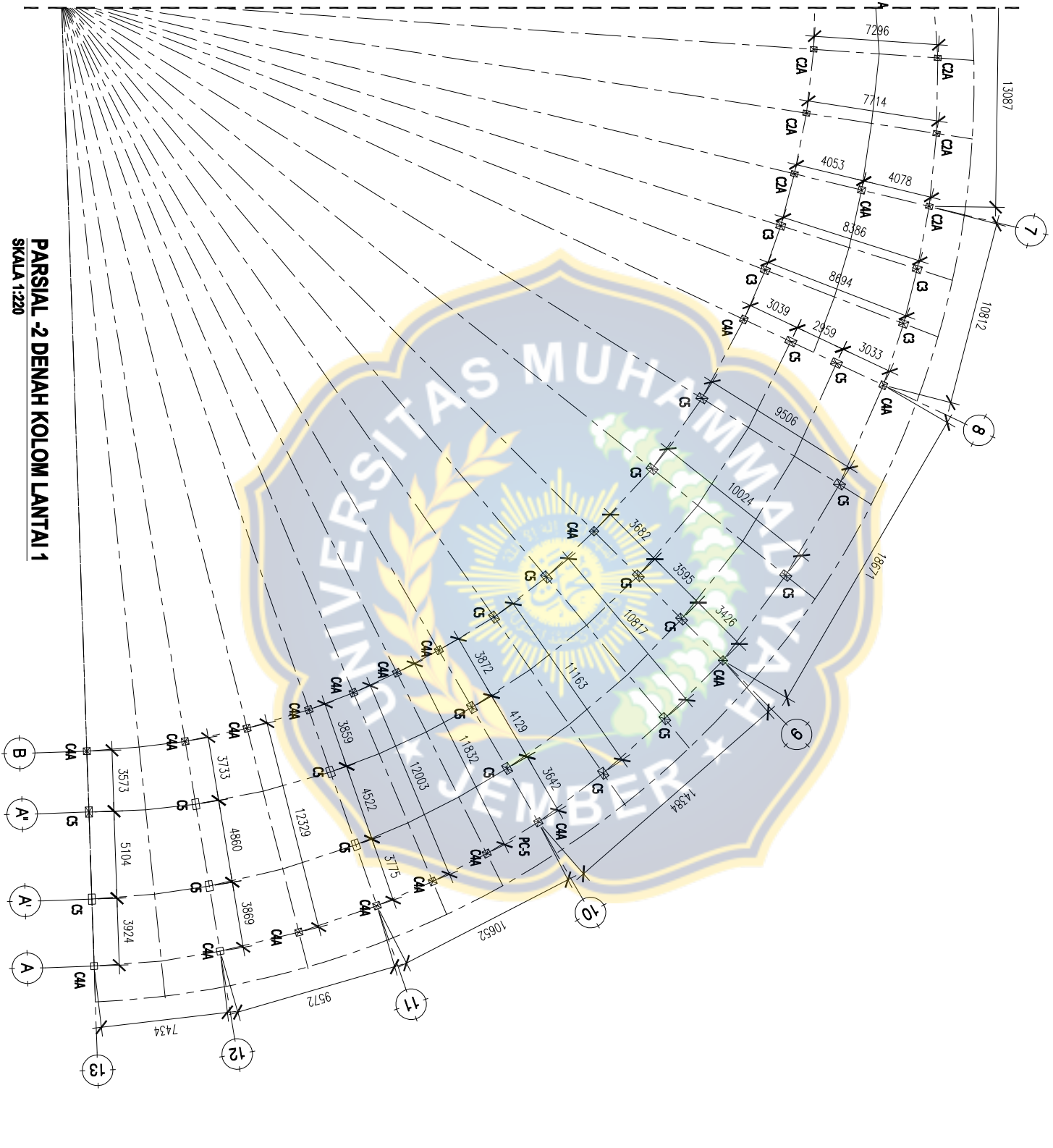

PARSIAL-2 DENAH KOLOM LANTAI 1
SKALA 1:220

NOTE

CONCRETE QUANTITY:
 BECON
 PILECAP, THE BEAM = K-250
 COLUMN, BEAM, SLAB = K-250
 BESI
 LUKU BUND 40 UAH (BERFORM)
 POLUS BHP 24 U24 (RUM)

DATE	REVISION

THE CONSTRUCTION OF INTEGRATED
 LAMPUNG UNIVERSITY OF TECHNOLOGY
 AND ACADEMY OF THE UNIVERSITY OF LAMPUNG

PROJECT SUPERVISION CONSULTANT

ENGINEER/ARCHITECT/STRUCTURAL ENGINEER
 ENGINEER/ARCHITECT/STRUCTURAL ENGINEER

TEAM LEADER	DATE	SIGN

CONTRACTOR

APPROVED BY	DATE	SIGN

CHIEF BY	DATE	SIGN

PT. HUTAJAYA KARYA - PT. NINDYA KARYA (CV)

SHOP DRAWING
 DRAWING GROUP
 TRAINING CENTER
 DIVISION
STRUKTUR
 DRAWING TITLE

SCALE	SHEET	DRAWING NO
1:220	3	8037M04.008

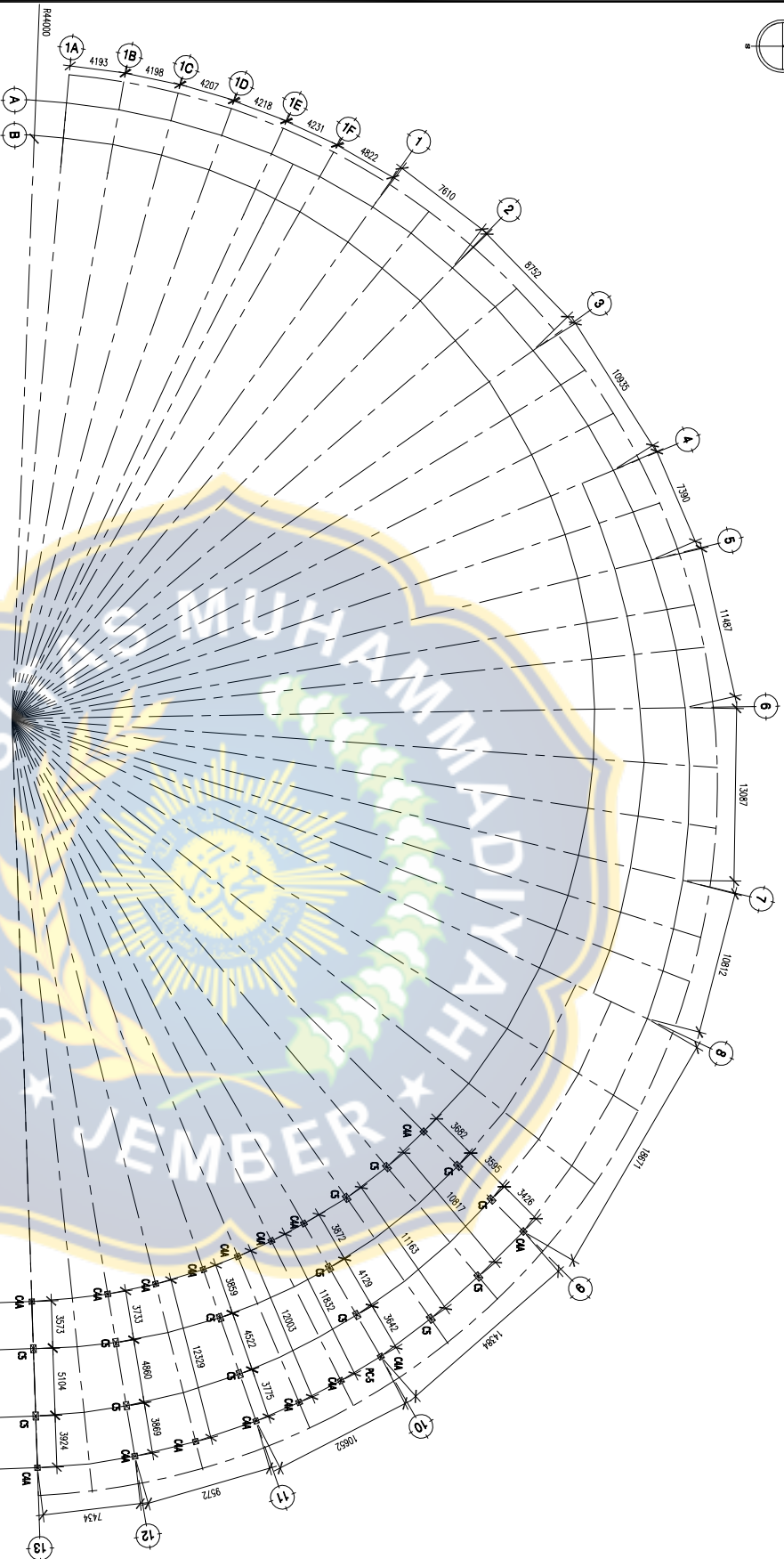

DENAH KOLOM LANTAI 2
SKALA 1:350

TABEL PENUNJANG KOLOM

DAMENSI	Tipe Kolom						
	C1	C2A	C2B	C3	CAALIT1	CAALIT2	CAB
300 X 300							
6-D16	10-D16	12-D16	12-D16	10-D16	8-D16	16-D16	14-D19
D10-150	D10-100	D10-100	D10-100	D10-100	D10-100	D10-100	D10-100
D10-200	D10-150	D10-150	D10-100	D10-100	D10-100	D10-100	D10-100

NOTE

CONCRETE QUANTITY :

BELOW
PIECAP, THE BEAM = K-250
COLUMN, BEAM, SLAB = K-250
RESI
LAIN BAWA 40 UAH (BERIKUT)
POLUS BTP 24 U24 (RUM)

REVISION

PROJECT



PROJECT SUPERVISION CONSULTANT

ENGINEER'S NAME AND ADDRESS OF THE CONTRACTOR

CONTRACTOR

DATE

DATE

DATE

DATE

DATE

DATE

DATE

DATE

DATE

DATE

DATE

DATE

DATE

DATE

DATE

DATE

SHOP DRAWING

DRAWING GROUP
TRAINING CENTER
DIVISION
STRUKTUR

DRAWING TITLE

DENAH KOLOM LANTAI 2

SCALE

1 : 350

SHEET

1 2

DRAWING NO

902.BTP.008

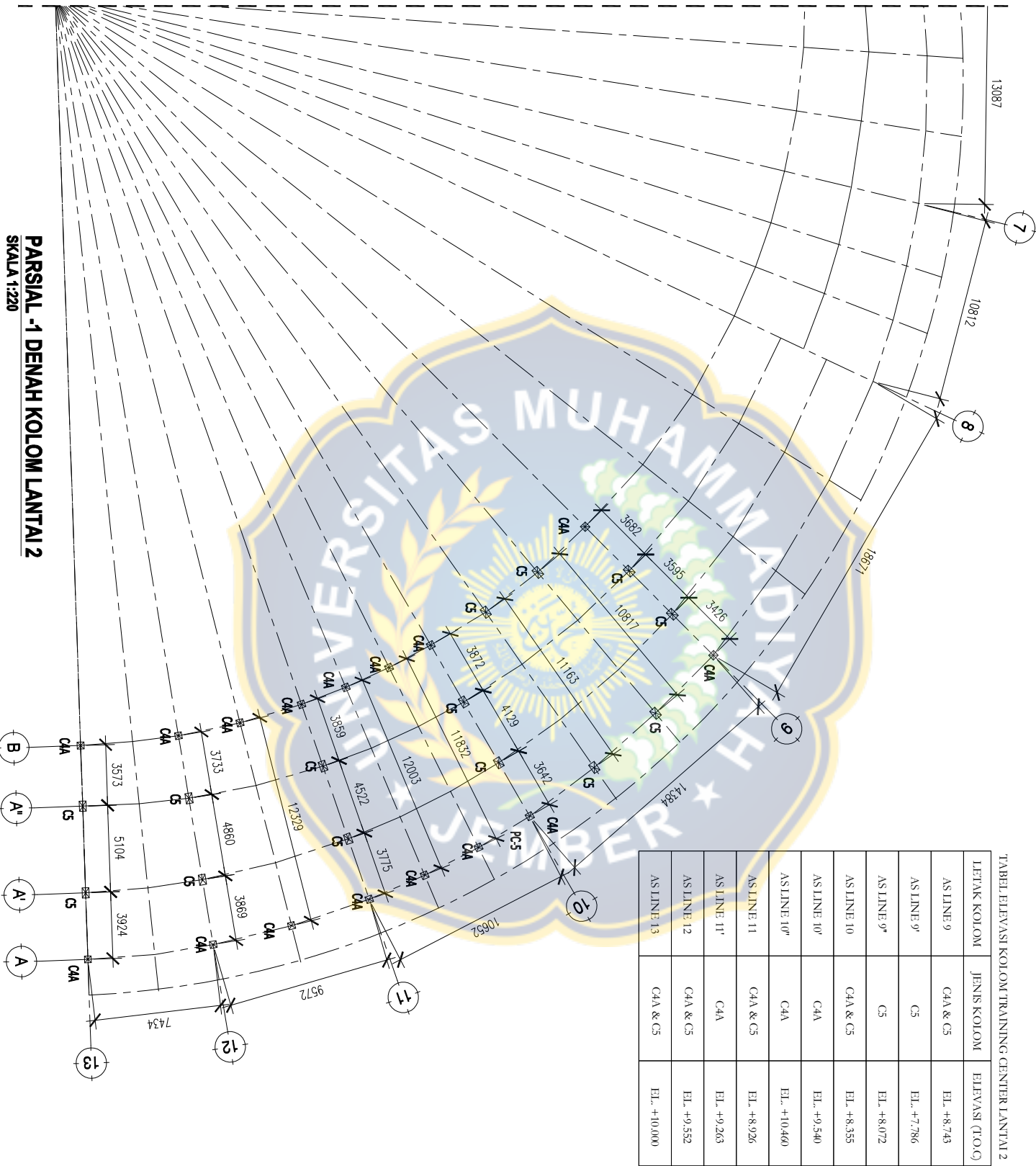

TABEL ELEVASI KOLOM TRAINING CENTER LANTAI 2

LETAK KOLOM	JENIS KOLOM	ELEVASI (T.O.C)
AS LINE 9	C4A & C5	EL. +8.743
AS LINE 9'	C5	EL. +7.786
AS LINE 9''	C5	EL. +8.072
AS LINE 10	C4A & C5	EL. +8.355
AS LINE 10'	C4A	EL. +9.540
AS LINE 10''	C4A	EL. +10.460
AS LINE 11	C4A & C5	EL. +8.926
AS LINE 11'	C4A	EL. +9.263
AS LINE 12	C4A & C5	EL. +9.552
AS LINE 13	C4A & C5	EL. +10.000

PARSIAL -1 DENAH KOLOM LANTAI 2
SKALA 1:220

NOTE

CONCRETE QUANTITY
 BEKON
 PILECAP, THE BEAM = K-250
 COLUMN, BEAM, SLAB = K-250
 RESI
 LULUR BUID 40 UAB (BERFORM)
 POUSS BTP 24 U24 (RUB)

THE CONSTRUCTION OF INTEGRATED LABORATORY FOR THE STUDENT OF THE AND AROUND OF THE UNIVERSITY OF SURAKARTA

PROJECT SUPERVISION CONSULTANT

ENGINEER/ARH. HIK. LUCY ANDER SUGANDHAWATI PERJAN

TEAM LEADER	DATE	SIKSI

CONTRACTOR

PT. PUTRAJAYA KARYA - PT. NINDYA KARYA (CV)

APPROVED BY	DATE	SIKSI
M. PRATIWI KOLAJIT		
W. HANUJAJIT		

CHIEF BY	DATE	SIKSI

DRAWN	DATE	SIKSI

SHOP DRAWING

DRAWING GROUP
 TRAINING CENTER
 DIVISION
STRUKTUR
 DRAWING TITLE

PARSIAL -1 DENAH KOLOM LANTAI 2

SCALE	SHEET	DRAWING NO
1:220	2	8037014.004

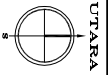

TABEL ELEVASI KOLOM TRAINING CENTER LANTAI 2

LETAK KOLOM	JENIS KOLOM	ELEVASI (T.O.C)
AS LINE 9	C4A & C5	EL. +8.743
AS LINE 9'	C5	EL. +7.786
AS LINE 9''	C5	EL. +8.072
AS LINE 10	C4A & C5	EL. +8.355
AS LINE 10'	C4A	EL. +9.540
AS LINE 10''	C4A	EL. +10.460
AS LINE 11	C4A & C5	EL. +8.926
AS LINE 11'	C4A	EL. +9.263
AS LINE 12	C4A & C5	EL. +9.552
AS LINE 13	C4A & C5	EL. +10.000

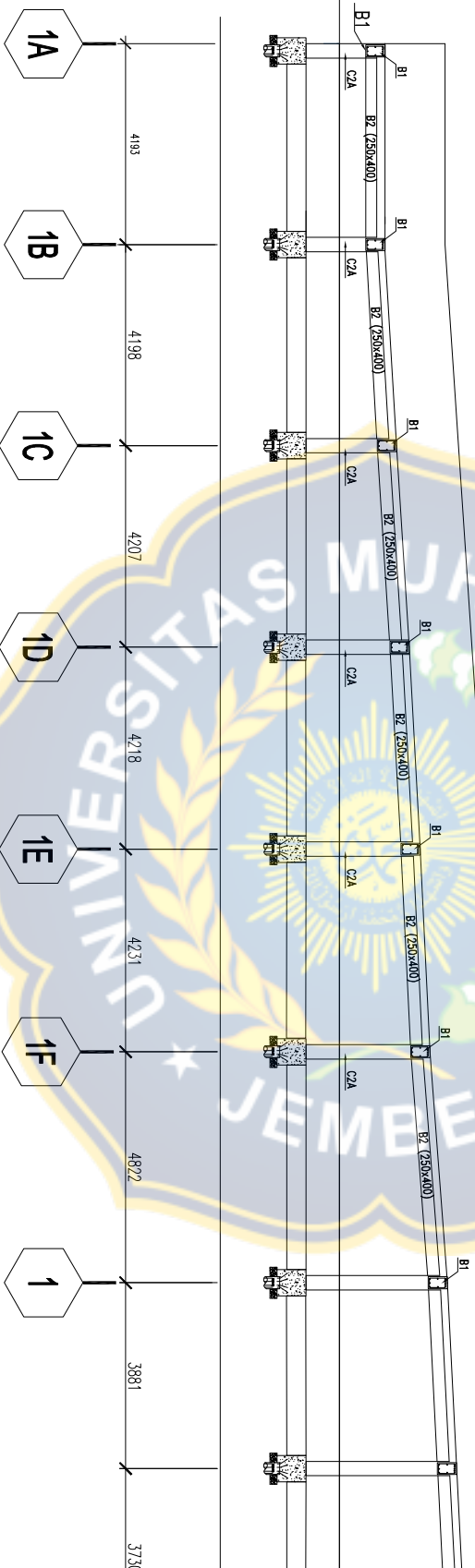

PORTAL AS-B

SCALE 1:125

PARSIAL -1 DENAH KOLOM LANTAI 2

SKALA 1:220

NOTE

CONCRETE QUALITY:
 BECON
 R/C CUP, THE BEAM = K-250
 COLUMN, BEAM, SLAB = K-250
 BESI
 LUKU BUD 40 U40 (BERFORM)
 POKS BTP 24 U24 (RUB)

REVISION

DATE PROJECT

THE CONSTRUCTION OF INTEGRATED TRAINING CENTER FOR THE FACULTY OF ENGINEERING AND ARCHITECTURE OF THE UNIVERSITY OF JEMBER
 PROJECT SUPERVISION CONSULTANT
 PT. HUTAJAYA KARYA - PT. NINDYA KARYA (CV)
 APPROVED BY: DATE: SIGN:
 M. PRATIWI
 MANAGER
 CHECKED BY: DATE: SIGN:
 ANAM TUNGKALIT
 SENIOR ENGINEER
 DRAWN BY: DATE: SIGN:
 R.O.M.O
 SENIOR

TRIAL LABORER DATE SIGN
 APPROVED BY: DATE: SIGN
 CONTRACTOR

SHOP DRAWING

DRAWING GROUP
 TRAINING CENTER
 DIVISION
 STRUKTUR
 DRAWING TITLE

PARSIAL -1 DENAH KOLOM LANTAI 2
 SCALE SHEET DRAWING NO
 1:220 2 2 S03RFD1.004

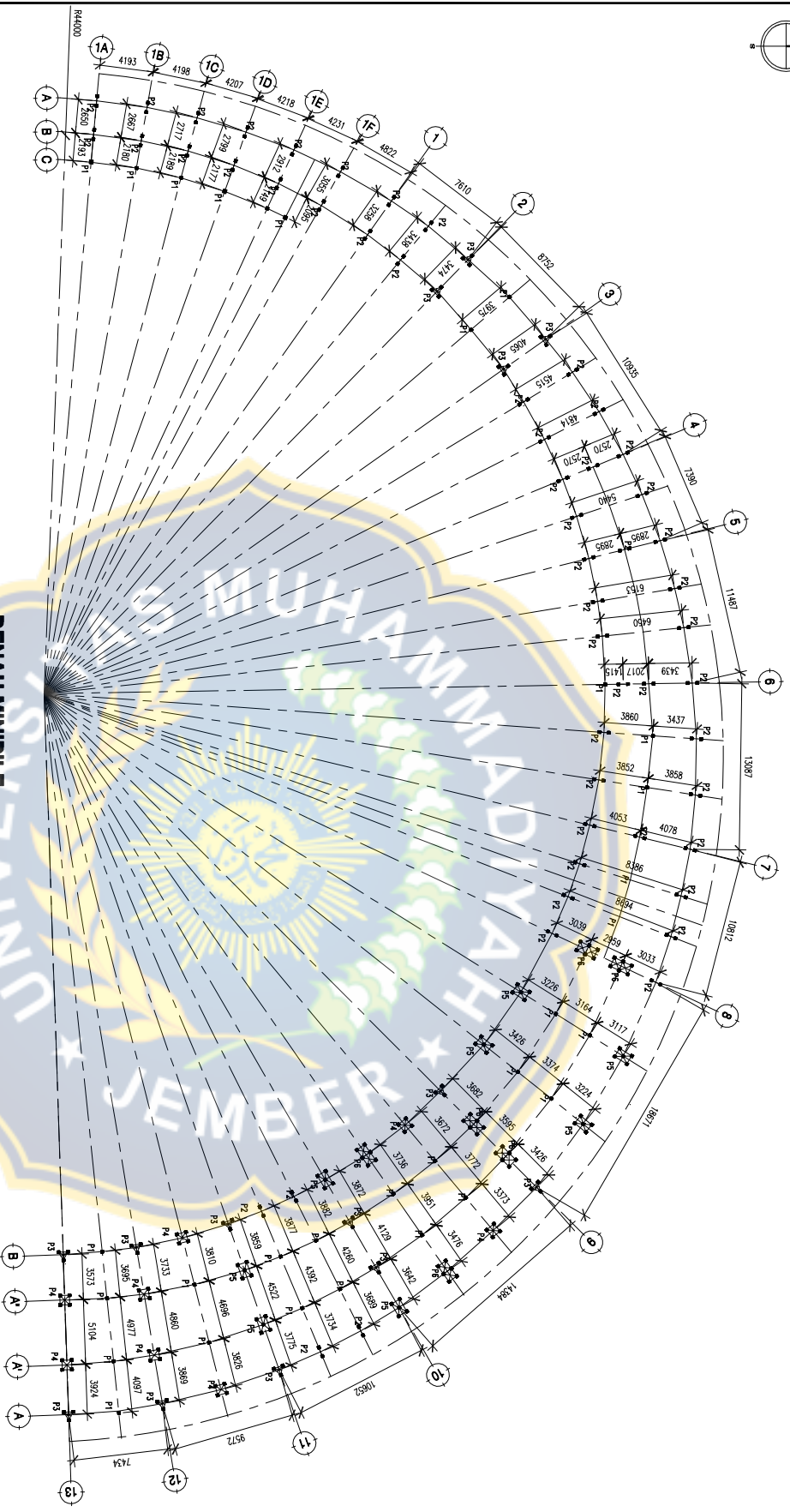

DENAH MINIPILE
SKALA 1:350

NOTE

CONCRETE QUANTITY:
 BECON
 PILECAP, THE BEAM = K-250
 COLUMN, BEAM, SLAB = K-250
 BESI
 LUKA BUD 40 U40 (DEFORM)
 POLUS BHP 24 U24 (RAN)

DATE	REVISION

PROJECT SUPERVISION CONSULTANT

ENGINEER/ARCHITECT

CONTRACTOR

PT. MUTIARA KARYA - PT. NINDYA KARYA (JV)

APPROVED BY	DATE	SIKIL
M. PRATIKO, ST		
M. HANIF, ST		

SHOP DRAWING

DRAWING GROUP
 TRAINING CENTER
 DIVISION
STRUKTUR
 DRAWING TITLE
 DENAH MINIPILE

SCALE	SHEET	DRAWING NO
1:350	1	902.BTR/01/01

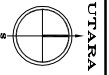

UTARA

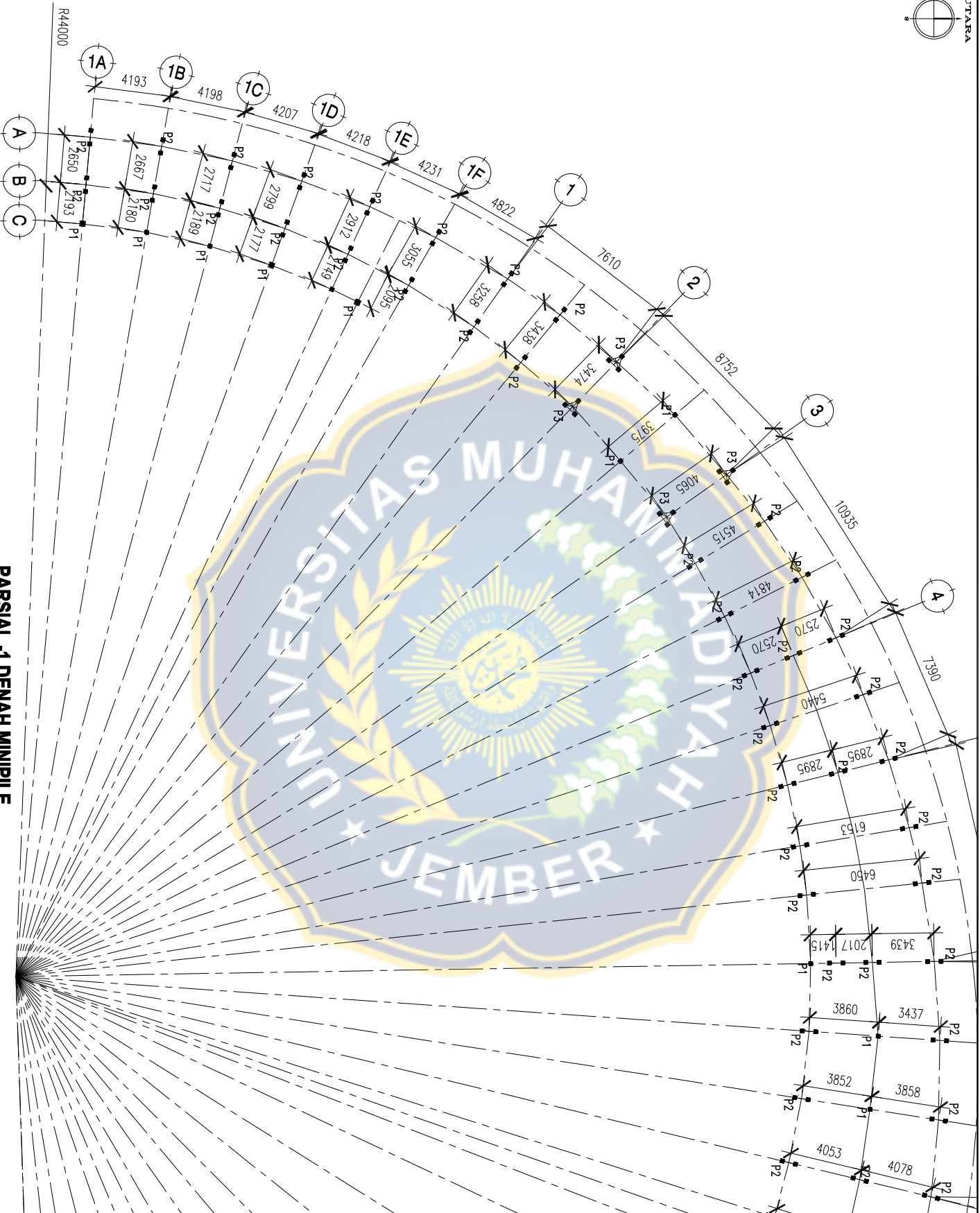

PARSIAL -1 DENAH MINPILE
SKALA 1:200

NOTE

CONCRETE QUANTITY :

BELOW
 PILECAP, THE BEAM = K-250
 COLUMN, BEAM, SLAB = K-250
 REISI
 LUMP BUND 40 UMB (GEBOW)
 POUSS BIMP 24 U24 (RUM)

DATE	REVISION

THE CONSTRUCTION OF INTEGRATED
 LABORATORY OF THE UNIVERSITY OF JEMBER
 AND AUDITORIUM OF THE UNIVERSITY OF JEMBER

PROJECT SUPERVISION CONSULTANT

PT. MUTIARA KARYA - PT. NINDYA KARYA
(CV)

TEAM LEADER	DATE	SIKSI

APPROVED BY	DATE	SIKSI

CHANGED BY	DATE	SIKSI

DRAWING TITLE	DATE	SIKSI

SHOP DRAWING

DRAWING GROUP
 TRAINING CENTER
 DIVISION
STRUKTUR
 DRAWING TITLE
 DENAH MINPILE

SCALE	SHEET	DRAWING NO
1:200	2	4

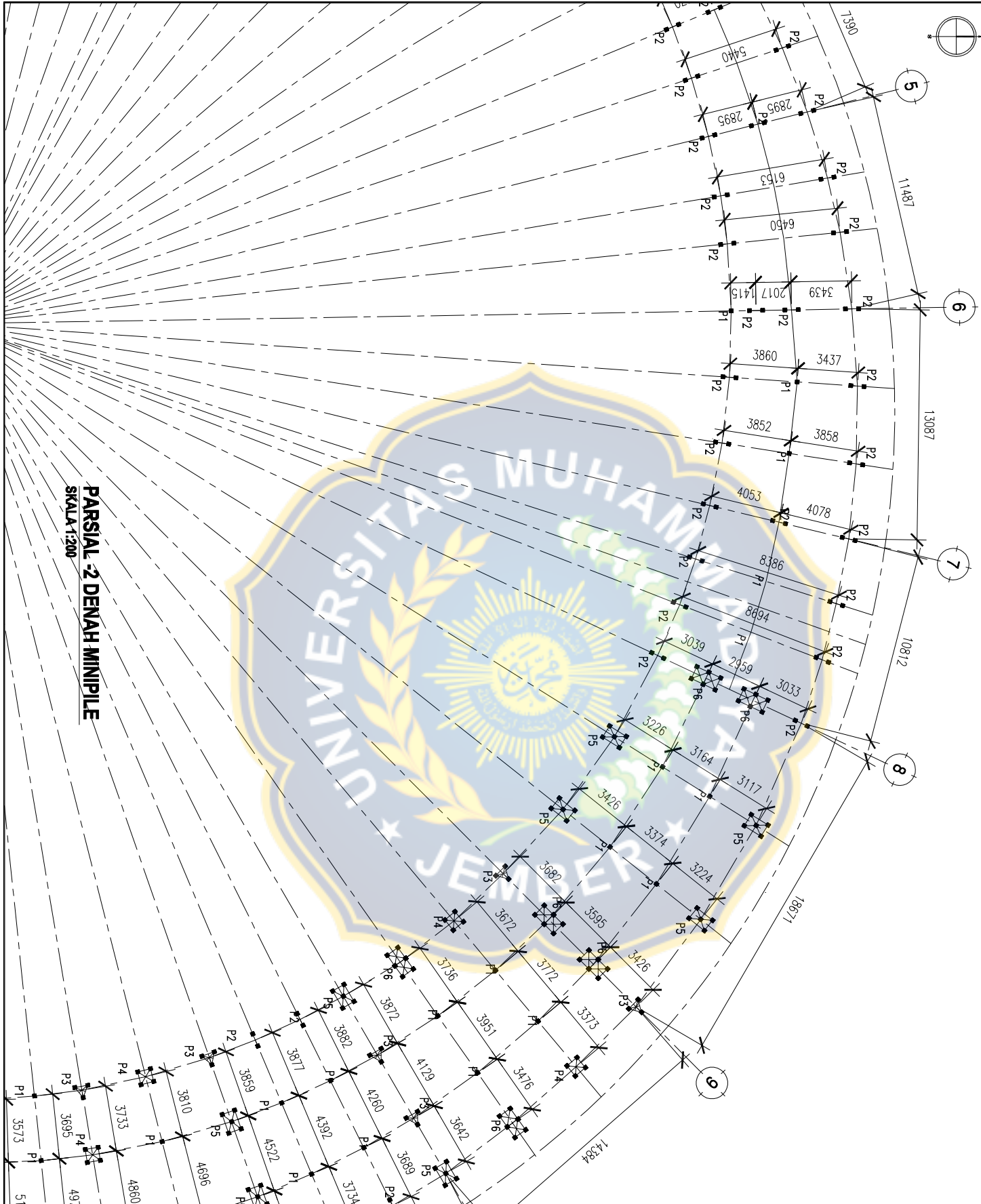

PARSIAL -2 DENAH MINIPILE
 SKALA:1:200

NOTE

CONCRETE QUANTITY:
 BECON
 PILECAP, THE BEAM = K-250
 COLUMN, BEAM, SLAB = K-250
 RESI
 LUKER BUND 40 UMB (BEFORM)
 POLUS BIMP 24 U24 (RUM)

DATE	REVISION

PROJECT

THE CONSTRUCTION OF INTEGRATED
 LEARNING CENTER FOR THE
 AND AUDITORIUM OF THE UNIVERSITY OF JEMBER

PROJECT SUPERVISION CONSULTANT

ENGINEER/ARCHITECT/STRUCTURAL ENGINEER
 PT. MUTIARA KARYA - PT. NINDYA KARYA
 (CV)

CONTRACTOR

APPROVED BY: DATE: SIGN:

APPROVED BY: DATE: SIGN:

APPROVED BY: DATE: SIGN:

APPROVED BY: DATE: SIGN:

APPROVED BY: DATE: SIGN:

SHOP DRAWING

DRAWING GROUP
 TRAINING CENTER

DIVISION
STRUKTUR

DRAWING TITLE

PARSIAL -2 DENAH MINIPILE

SCALE	SHEET	DRAWING NO
1:200	3	803701.018
	4	

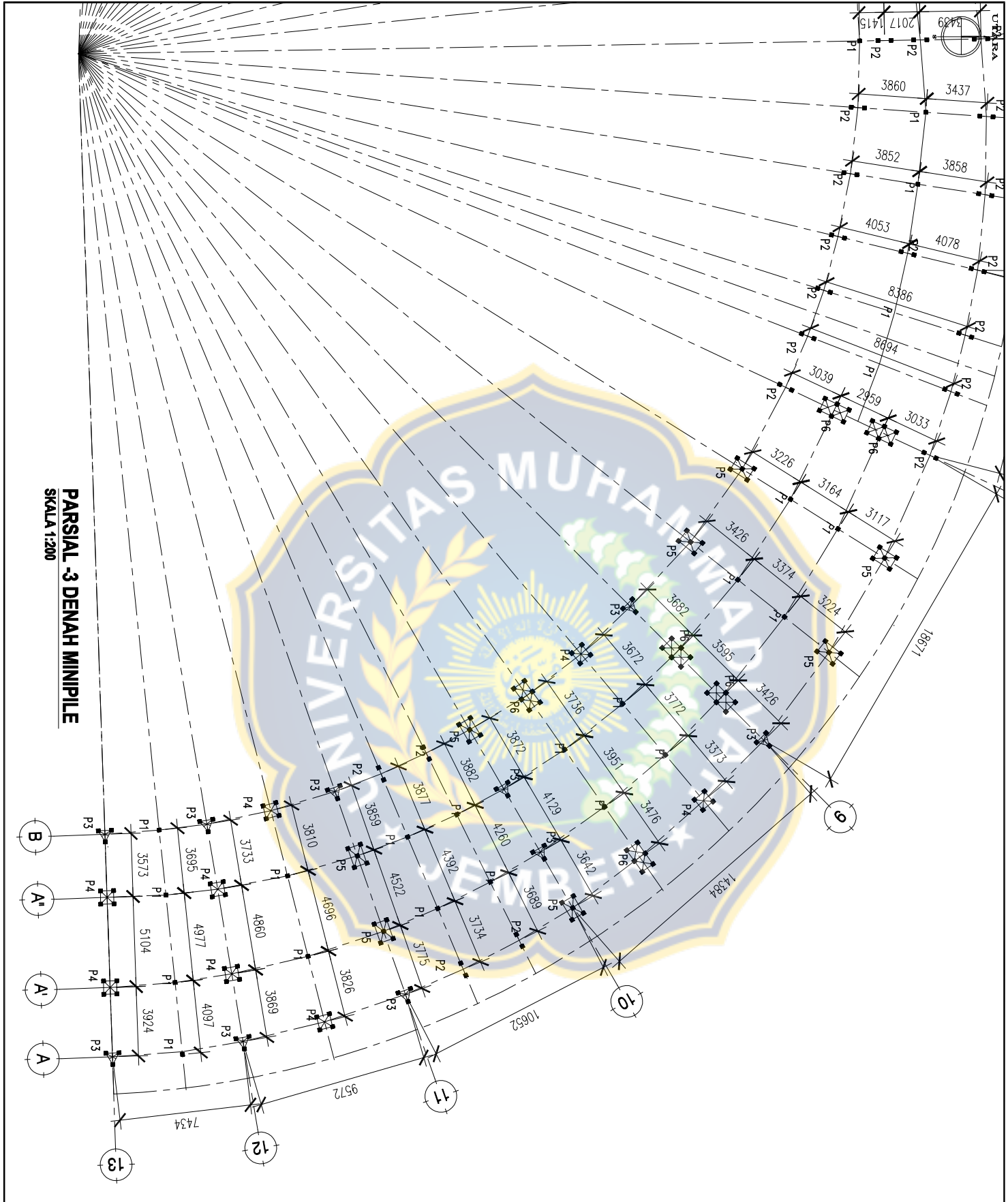

PARSIAL -3 DENAH MINIPILE
SKALA 1:200

NOTE

CONCRETE QUANTITY:
 BECON
 PILECAP, THE BEAM = K-250
 COLUMN, BEAM, SLAB = K-250
 BESI
 LUKA BUND 40 UMB (BEKON)
 POLUS BHP 24 U24 (RUM)

REVISION

DATE	REVISION

PROJECT

THE CONSTRUCTION OF INTEGRATED
 LEARNING AND RESEARCH CENTER
 AND AUDITORIUM OF THE UNIVERSITY OF JEMBER

PROJECT SUPERVISION CONSULTANT

PT. MUTIARA KARYA - PT. NINDYA KARYA
 (CV)

CONTRACTOR

PT. MUTIARA KARYA - PT. NINDYA KARYA
 (CV)

APPROVED BY

M. PRATIWI
 M. PRATIWI
 M. PRATIWI

CHECKED BY

A. M. H. ...
 A. M. H. ...
 A. M. H. ...

SHOP DRAWING

DRAWING GROUP
 TRAINING CENTER
 DIVISION
STRUKTUR
 DRAWING TITLE

PARSIAL -3 DENAH MINIPILE

SCALE	SHEET	DRAWING NO
1:200	4	03030101010

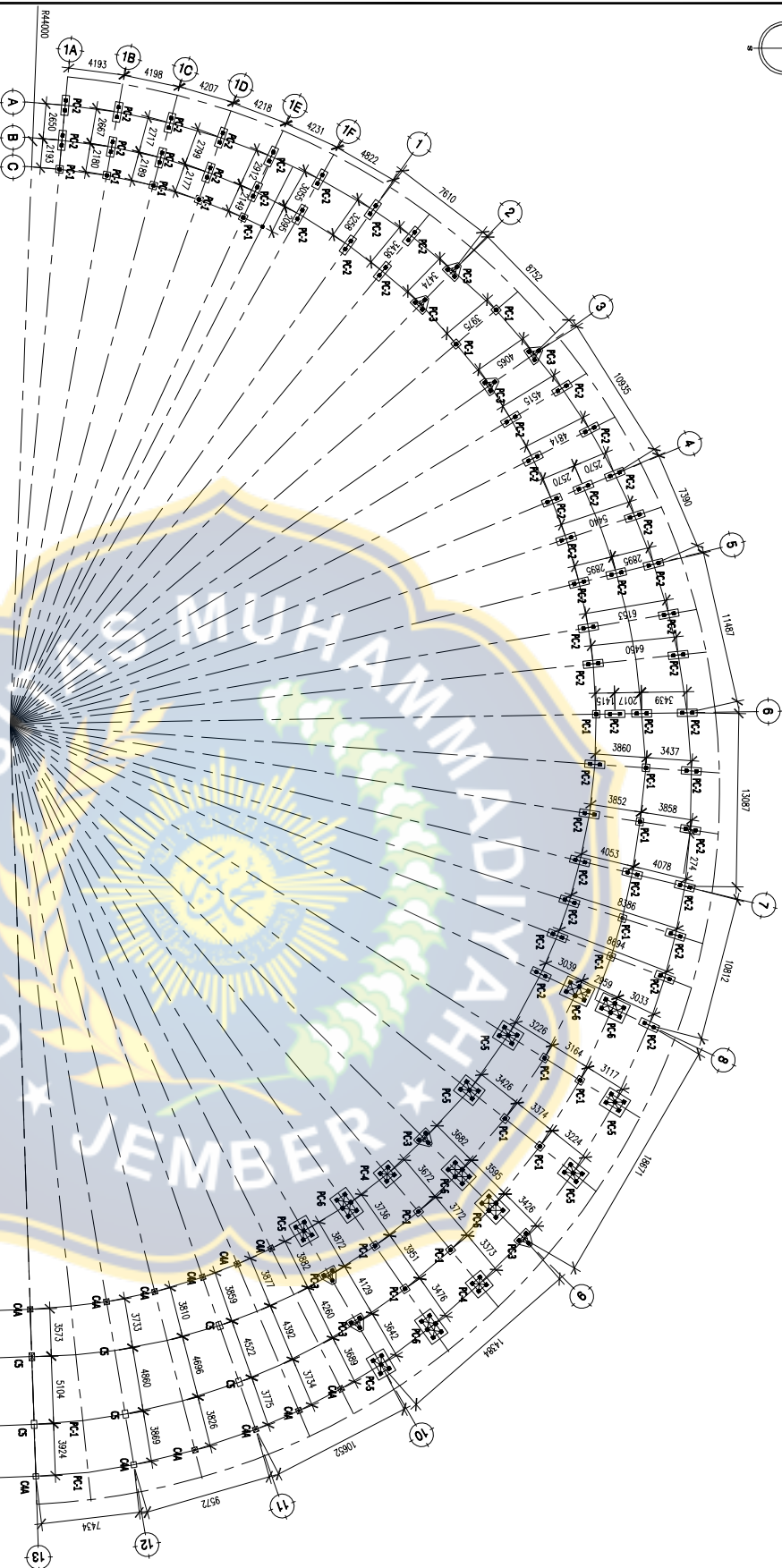

DENAH PILECAP
SKALA 1:350

NOTE

CONCRETE QUANTITY:
 BECON
 PILECAP, THE BEAM = K-250
 COLUMN, BEAM, SLAB = K-250
 BESI
 LUKA BOND 40 UAD (BERFORM)
 POLUS BTP 24 U24 (RAM)

DATE	REVISION

THE CONSTRUCTION OF INTEGRATED
 LAMPUNG TRAINING CENTER FOR
 AND ADMINISTRATION OF THE UNIVERSITY OF LAMPUNG

PROJECT SUPERVISION CONSULTANT

ENGINEER/ARCHITECT/STRUCTURAL ENGINEER
 PT. MUTIARA KARYA - PT. NINDYA KARYA
 (CV)

TEAM LEADER	DATE	SIKHN

CONTRACTOR	DATE	SIKHN

APPROVED BY	DATE	SIKHN
M. PRATIWI MANAGER		

CHECKED BY	DATE	SIKHN

DRAWN	DATE	SIKHN

SHOP DRAWING

DRAWING GROUP
 TRAINING CENTER

DIVISION
STRUKTUR

DRAWING TITLE
 DENAH PILECAP

SCALE	SHEET	DRAWING NO
1:350	1	903.BTP.002

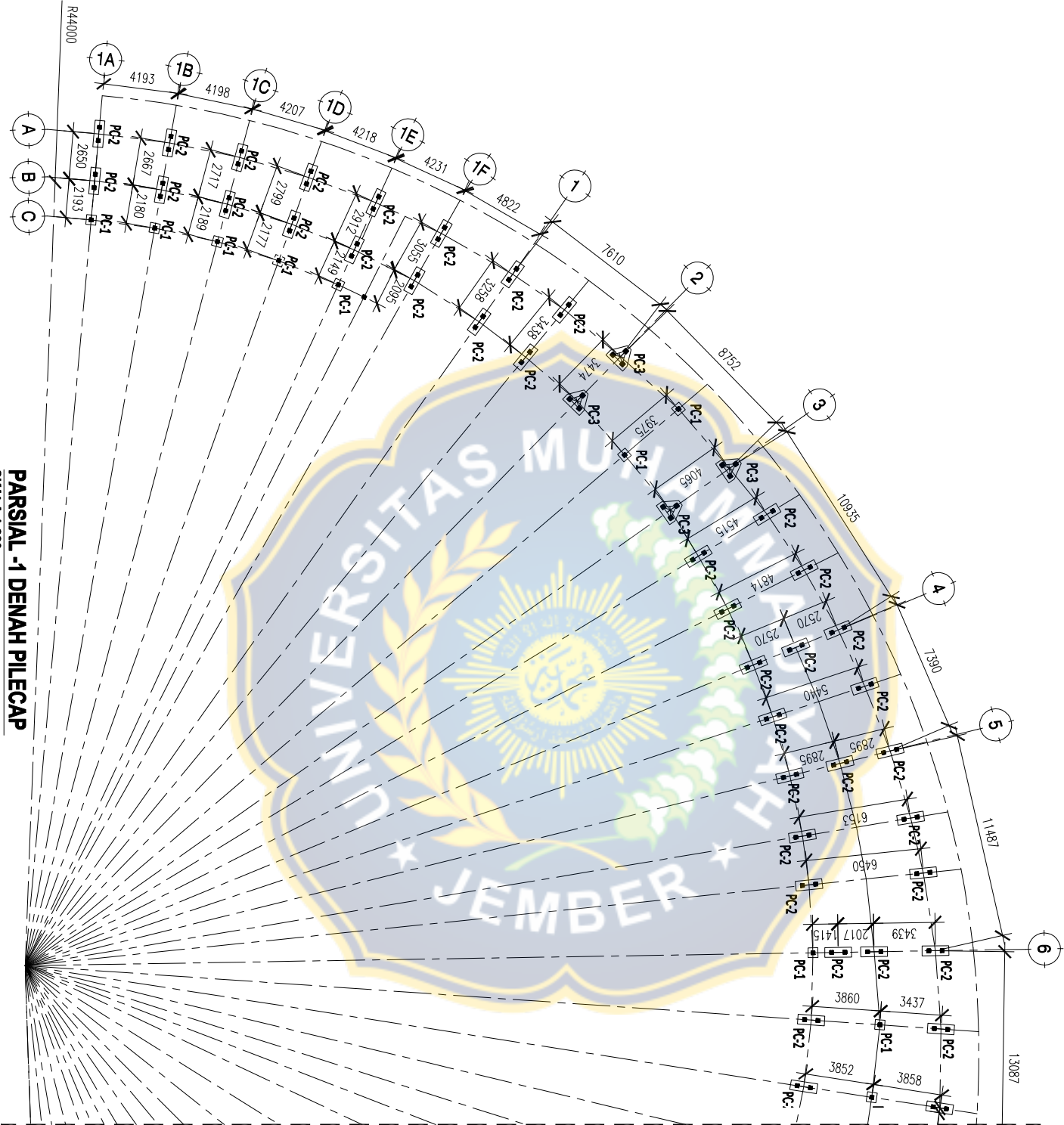

PARSIAL -1 DENAH PILECAP
SKALA 1:220

NOTE

CONCRETE QUANTITY:
 BECON
 PILECAP, THE BEAM = K-250
 COLUMN, BEAM, SLAB = K-250
 BESI
 LUKU BUND 40 UJUK (BERFORM)
 POUSS BTP 24 U24 (RUM)

REVISION

DATE	REVISION

PROJECT

THE CONSTRUCTION OF INTEGRATED
 LABORATORY BUILDING FOR THE
 AND AUDITORIUM OF THE UNIVERSITY OF JEMBER

PROJECT SUPERVISION CONSULTANT

PT. MUTIARA KARYA - PT. NINDYA KARYA
(CV)

CONTRACTOR

PT. MUTIARA KARYA - PT. NINDYA KARYA
(CV)

APPROVED BY

M. PRATIWI
 M. PRATIWI
 M. PRATIWI

CHIEF BY

M. PRATIWI
 M. PRATIWI
 M. PRATIWI

DRAWN

M. PRATIWI
 M. PRATIWI
 M. PRATIWI

SHOP DRAWING

DRAWING GROUP
 TRAINING CENTER
 DIVISION
STRUKTUR
 DRAWING TITLE

PARSIAL -1 DENAH PILECAP

SCALE	SHEET	DRAWING NO
1:220	2	3

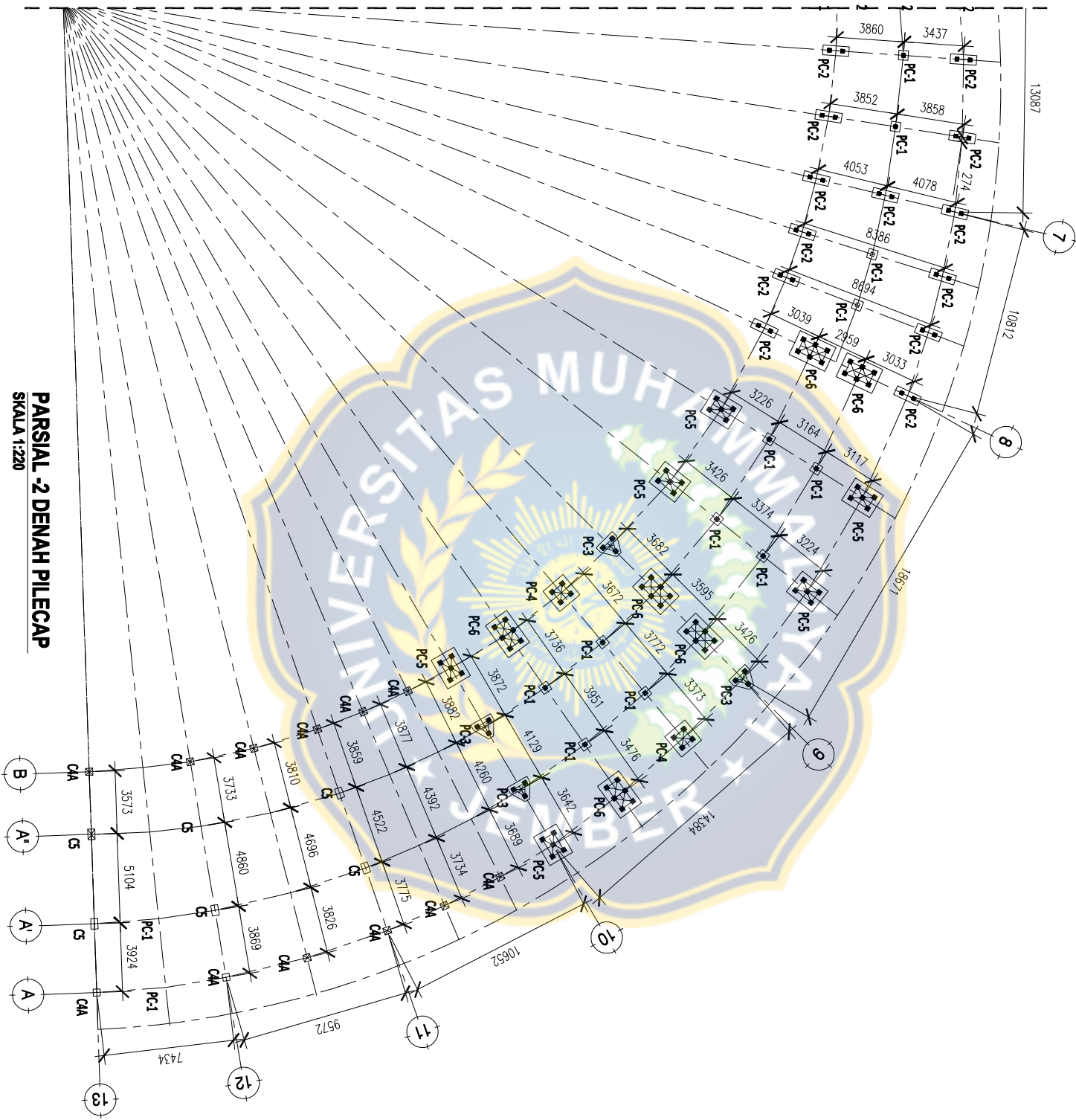

PARSIAL -2 DENAH PILECAP
SKALA 1:220

NOTE

CONCRETE QUANTITY:
 BECON
 PILECAP, THE BEAM = K-250
 COLUMN, BEAM, SLAB = K-250
 RESI
 LUKUR BUND 40 UMB (BERFORM)
 POLUS BHP 24 U24 (RUM)

DATE	REVISION

PROJECT SUPERVISION CONSULTANT

ENGINEER'S NAME: ...
 ADDRESS: ...

CONTRACTOR

APPROVED BY: ...
 DATE: ...
 SIGN: ...

DESIGNED BY: ...
 DATE: ...
 SIGN: ...

DRAWN BY: ...
 DATE: ...
 SIGN: ...

SHOP DRAWING
 DRAWING GROUP
 TRAINING CENTER
 DIVISION
STRUKTUR
 DRAWING TITLE

SCALE	1:220
SHEET	3
DRAWING NO	S03BTR01.0028

DETAIL PILE CAP PC-1, Qty = 30 UNIT

KEY PLAN

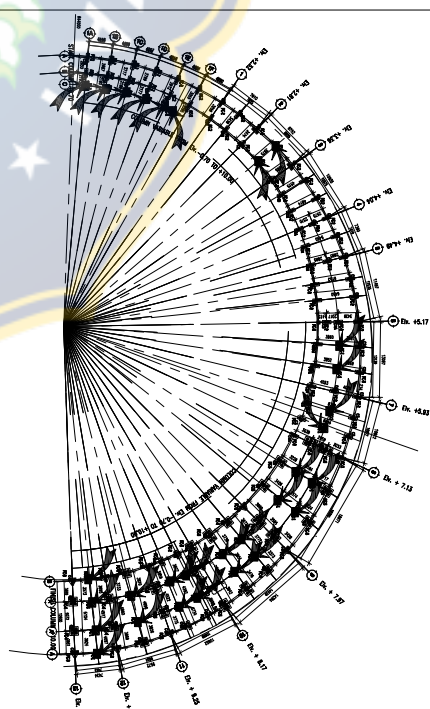
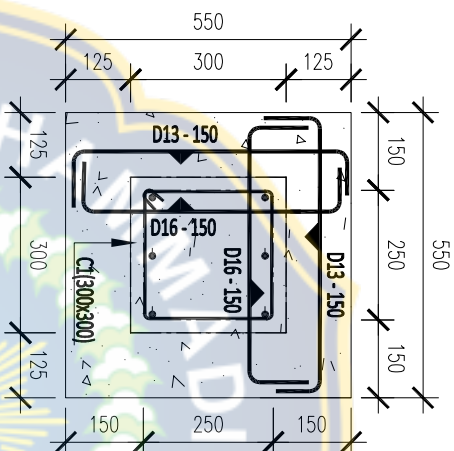
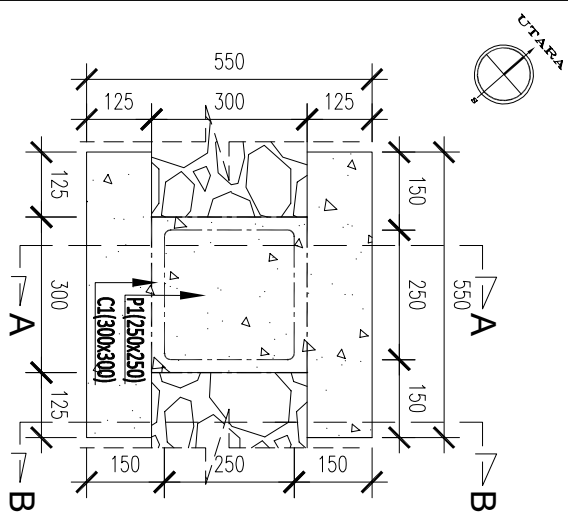

NOTE
CONCRETE QUALITY:

BELOW
PILE CAP, THE BEAM = K-250
COLUMN, BEAM, SLAB = K-250
REIN
DUR BMD 40 (D250M)
PLUS BMT 24 (M4) (F1M)

DATE	REVISION
22/01/2019	RO PERBAKIKAN DIRUBAH FORM & KET

PROJECT SUPERVISION CONSULTANT
PT. HUTAJAYA KARYA - PT. NINDYA KARYA (CV)

DESIGNER
PT. HUTAJAYA KARYA - PT. NINDYA KARYA (CV)

APPROVED BY
M. PRADIPRAJIT
W. HENDRIJIT
A. M. HENDRIJIT
T. H. M. HENDRIJIT

DRAWN
R. D. M. D.

SHOP DRAWING

DRAWING GROUP
TRAINING CENTER
DIVISION
STRUKTUR

SCALE	SHEET	DRAWING NO
1:10	1	SB.STRUC.003

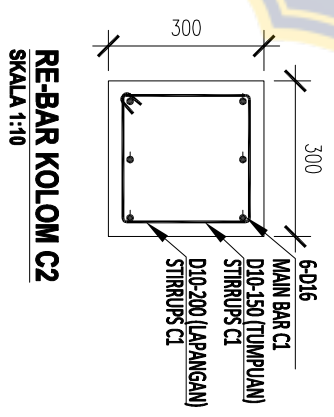
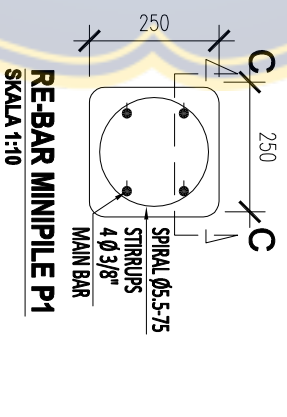
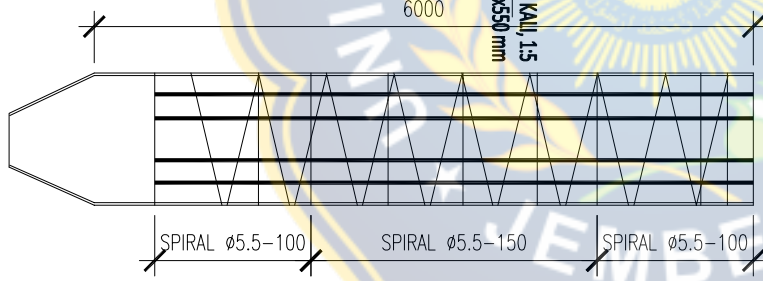
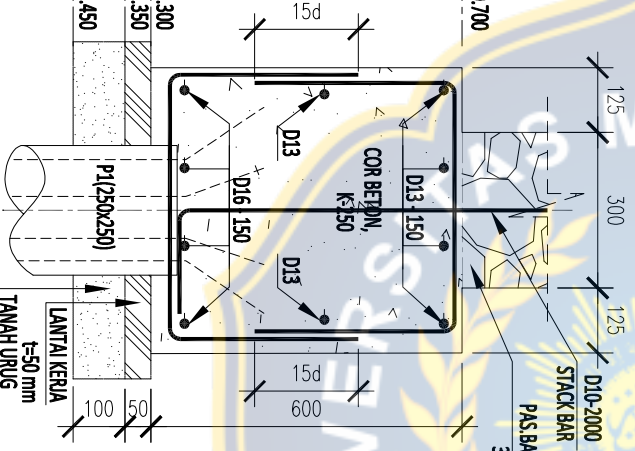
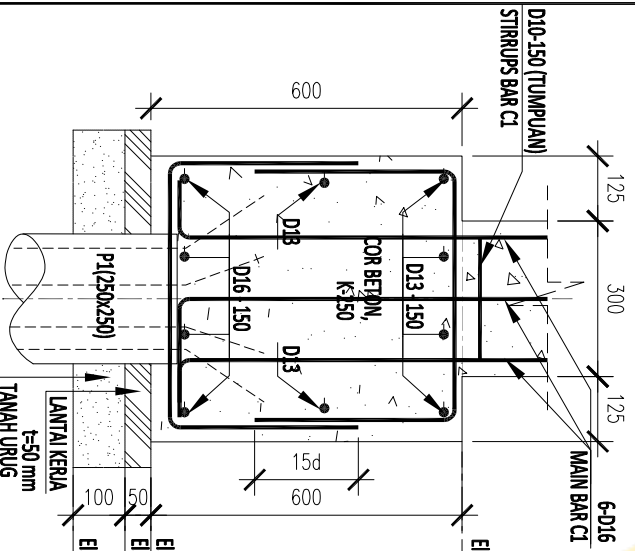

DETAIL PILE CAP PC-2, Qty = 36 UNIT

KEY-PLAN

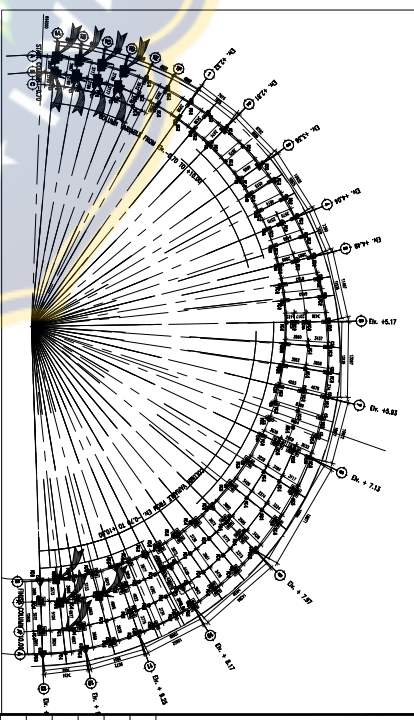
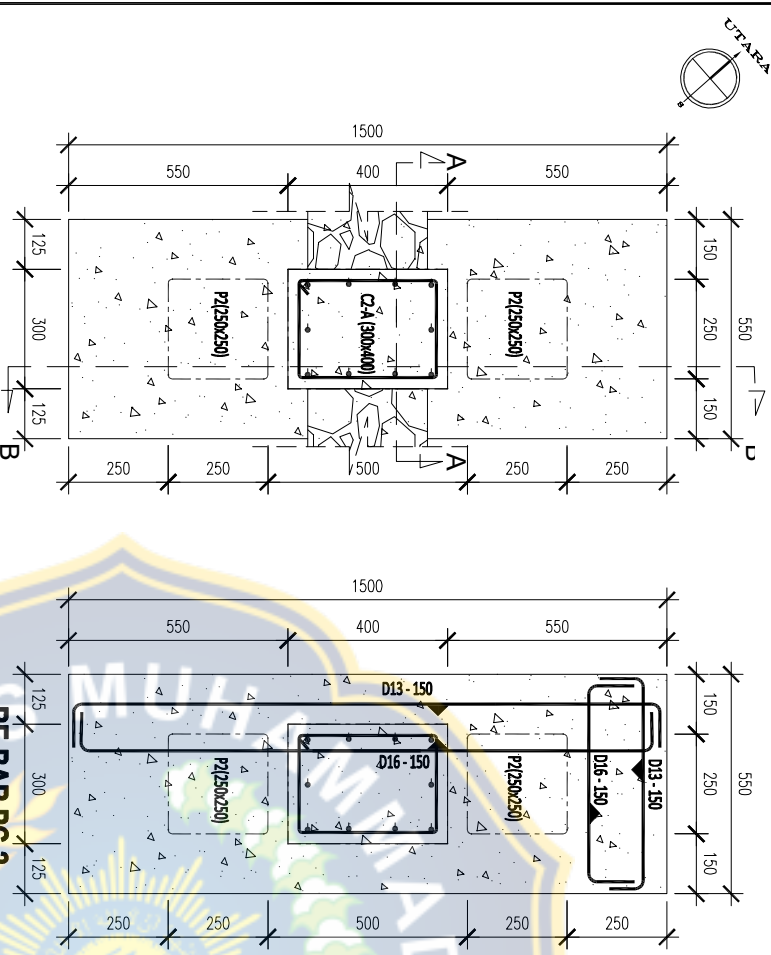

LAY-OUT PC-2
SKALA 1:10

REBAR PC-2
SKALA 1:10

REBAR KOLONG C2-A
SKALA 1:10

REBAR MINIPILE P2
SKALA 1:10

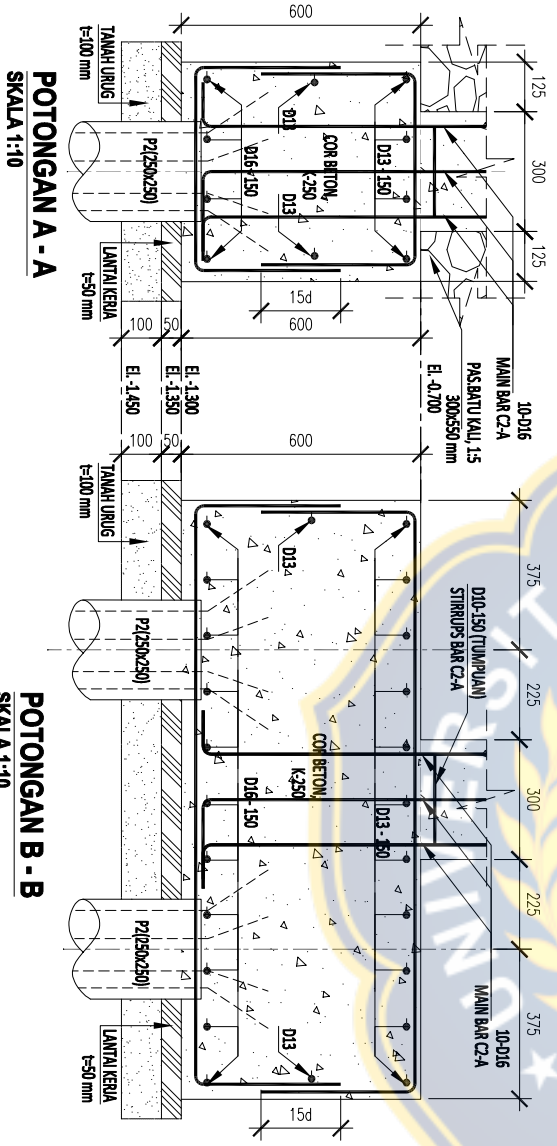

POTONGAN A - A
SKALA 1:10

POTONGAN B - B
SKALA 1:10

POTONGAN C - C
SKALA 1:10

NOTE

CONCRETE QUALITY:
 BERTON
 PILE CAP, TIE BEAM = K-250
 COLUMN, BEAM, SLAB = K-250
 BESI
 UJUK BMD 40 UJUK (B270M)
 PULAS BMT 24 UJUK (F14)

DATE	REVISION
22/01/2019	RO PERBAIKAN DURSIAN TOWER & KET

PROJECT	REVISION
THE CONSTRUCTION OF INTEGRATED LAMPUNG UNIVERSITY OF TECHNOLOGY AND AGRICULTURE OF THE UNIVERSITY OF JEMBER	

PROJECT SUPERVISION CONSULTANT	DATE	SIKSN
ESKAMU (Konsultan Rekayasa dan Konstruksi)		

TRIAL LABOR	DATE	SIKSN

CONTRACTOR	DATE	SIKSN
PT. NATALIA KARYA - PT. NINDYA KARYA (JV)		

APPROVED BY	DATE	SIKSN
M. PRATIKO ARI		
W. HANIK ARI		
CHIEF BY	DATE	SIKSN
ANAM TUNGKAL ET		
TRIA M. WIDYANINGRAT		
DRAWN	DATE	SIKSN
R. D. M. D.		
CHECKED	DATE	SIKSN

SHOP DRAWING

DRAWING GROUP
TRAINING CENTER

DIVISION
STRUKTUR

DRAWING TITLE
DETAIL PILE CAP PC-2

SCALE	SHEET	DRAWING NO
1:10	2	SBSTR01.004

DETAIL PILE CAP PC-3A, QTY = 4 UNIT

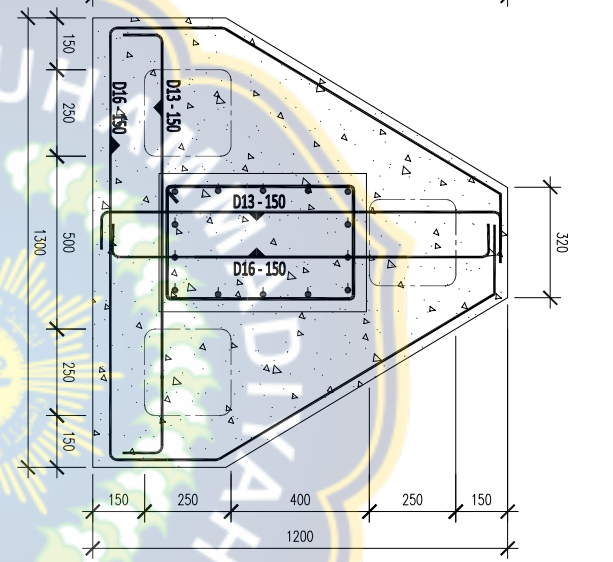
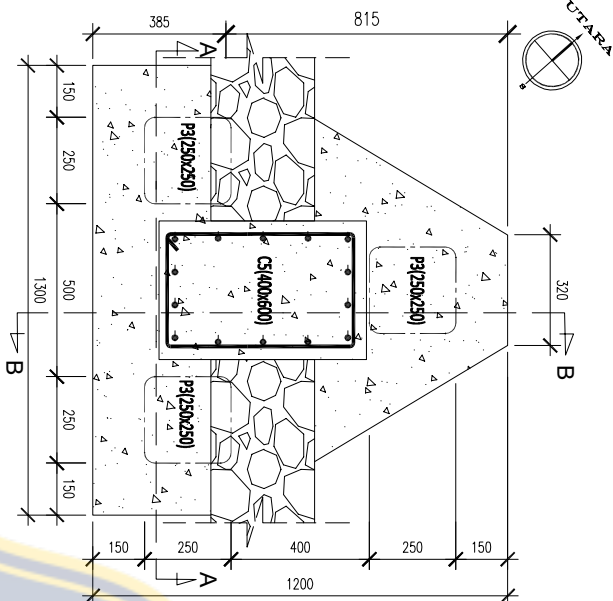

KEY PLAN

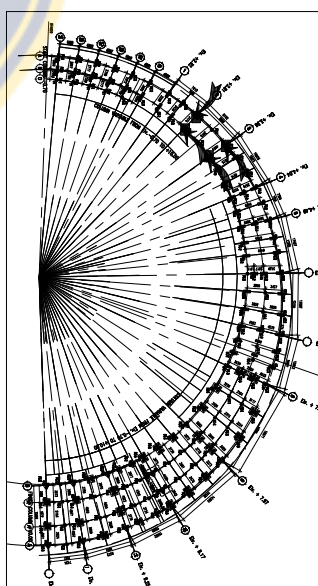

NOTE

CONCRETE QUALITY:
 BETON
 PILE CAP, TIE BEAM = K-250
 COLUMN, BEAM, SLAB = K-250
 BESI
 UJUK BMD 40 UJUK (B270M)
 POKUS BMT 21 UJUK (FUM)

LAYOUT PC-3A
 SKALA 1:15

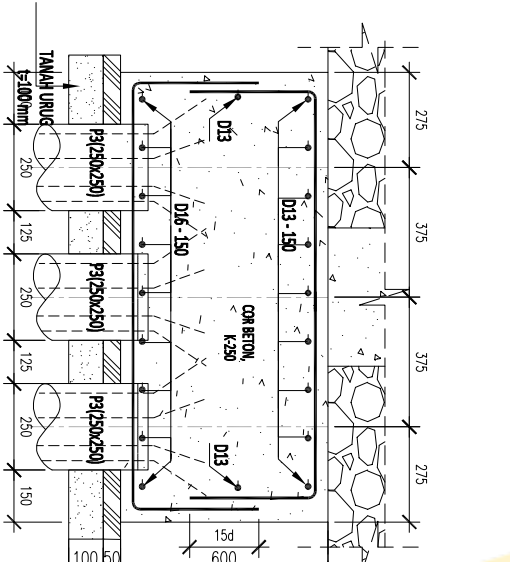

RE-BAR PC-3A
 SKALA 1:15

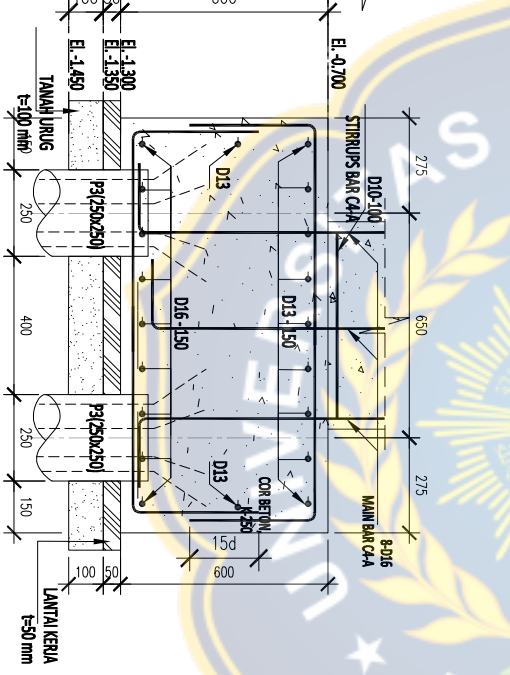

REBAR KOLOM C5
 SKALA 1:15

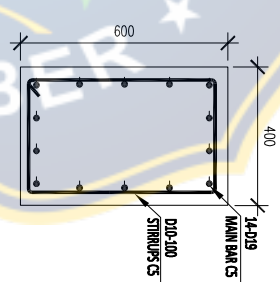

RE-BAR MINPILE P3
 SKALA 1:15

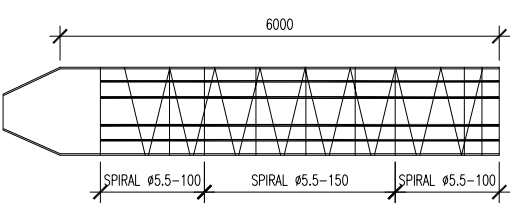

POTONGAN A - A
 SKALA 1:15

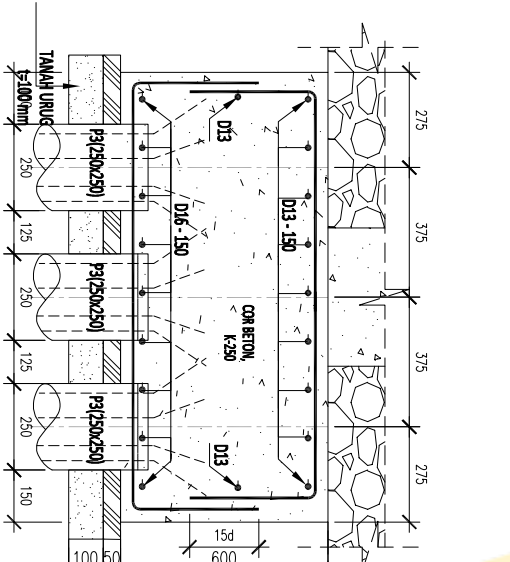

POTONGAN B - B
 SKALA 1:15

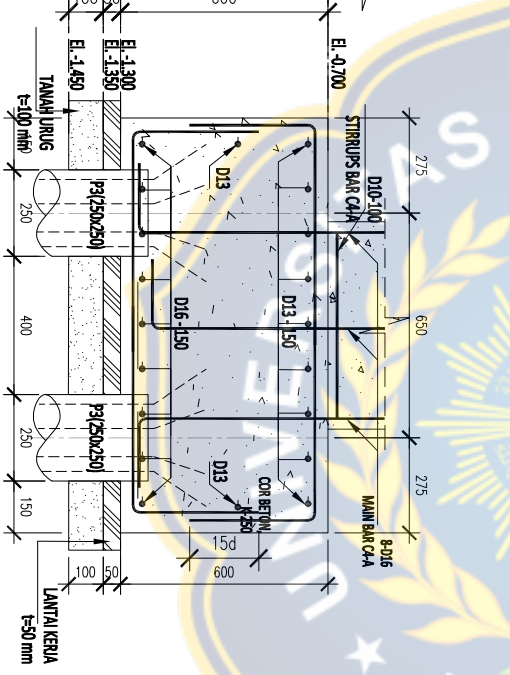

POTONGAN C - C
 SKALA 1:15

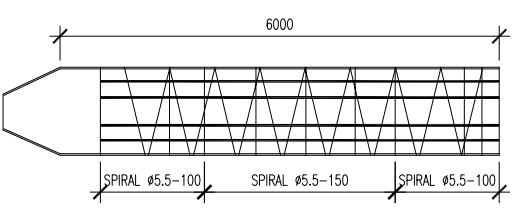

SHOP DRAWING

DRAWING GROUP
 TRAINING CENTER
 DIVISION
STRUKTUR
 DRAWING TITLE

DETAIL PILE CAP PC-3A

SCALE	SHEET	DRAWING NO
1:10	3	8037M01.008

PROJECT SUPERVISION CONSULTANT	DESIGNER	DATE	SIKSI
PT. HUTAJAYA KARYA - PT. NINDYA KARYA (CV)	M. PRATYAKO, ET		
APPROVED BY	DATE	SIKSI	
M. PRATYAKO, ET			
WAKILAH, ET			
CHECKED BY	DATE	SIKSI	
ANAKI TRISNANTI, ET			
TRIA MURNI, ET			
DRAWN	DATE	SIKSI	
R.O.M.O			
DATE			

DETAIL PILE CAP PC-3B, QTY = 10 UNIT

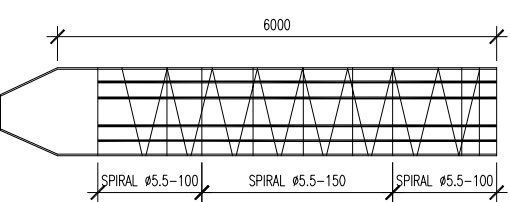
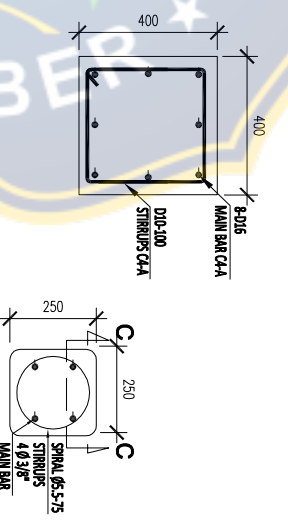
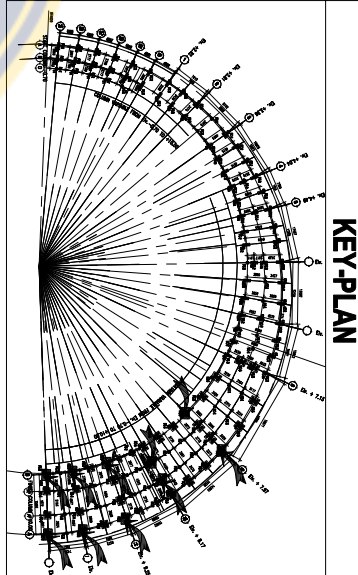
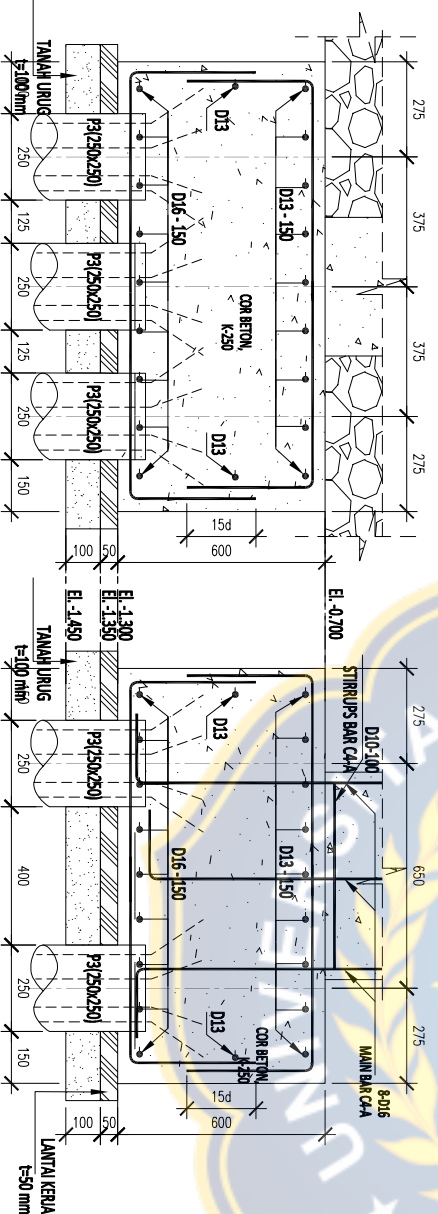
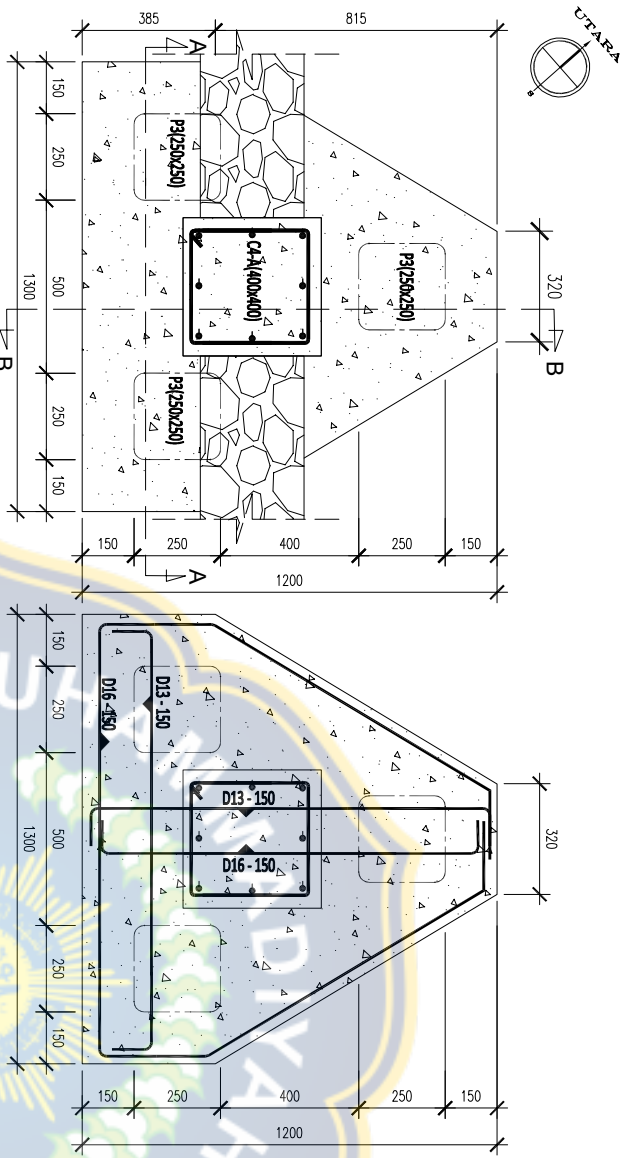

NOTE

CONCRETE QUALITY:
 BETA
 PILE CAP, TIE BEAM = K-250
 COLUMN, BEAM, SLAB = K-250
 BESI
 UJUK BMD 40 UJUK (035700)
 PUSUK BMT 24 UJUK (PUN)

DATE	REVISION
22-01-2019	RO PERBAIKAN URUNAN TITIK & KET

PROJECT SUPERVISION CONSULTANT

DESIGNER

CONTRACTOR

PT. HUTAJAYA KARYA - PT. NINDYA KARYA (CV)

APPROVED BY	DATE	SIKIL
M. PRATIKNO, I.T		
M. PRATIKNO, I.T		
DIAN NINGSIH, I.T		
TRIA MURNI, I.T		
DRAWN	DATE	SIKIL
R.O.M.O		

SHOP DRAWING

DRAWING GROUP
 STRUKTUR

DRAWING TITLE
 DETAIL PILE CAP PC-3B

SCALE	SHEET	DRAWING NO
1:10	4	803701.003C

DETAIL PILE CAP PC-4, Qty = 8 UNIT

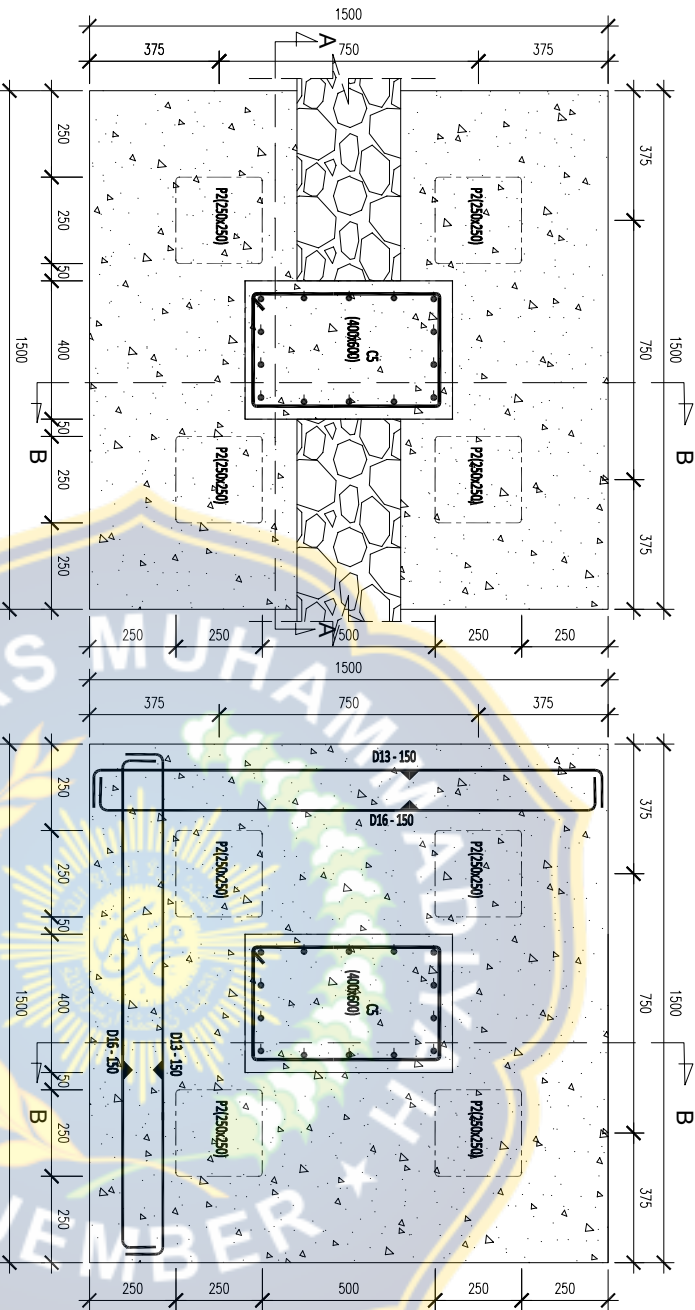

LAY-OUT PC-4
SKALA 1:15

RE-BAR PC-4
SKALA 1:15

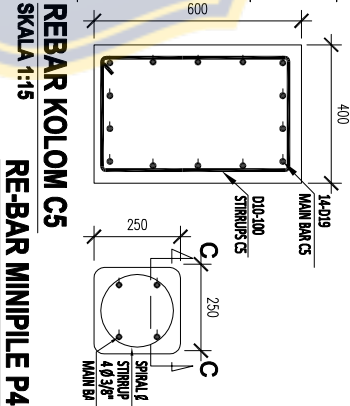

RE-BAR KOLON C5
SKALA 1:15

RE-BAR MINIPILE P4
SKALA 1:15

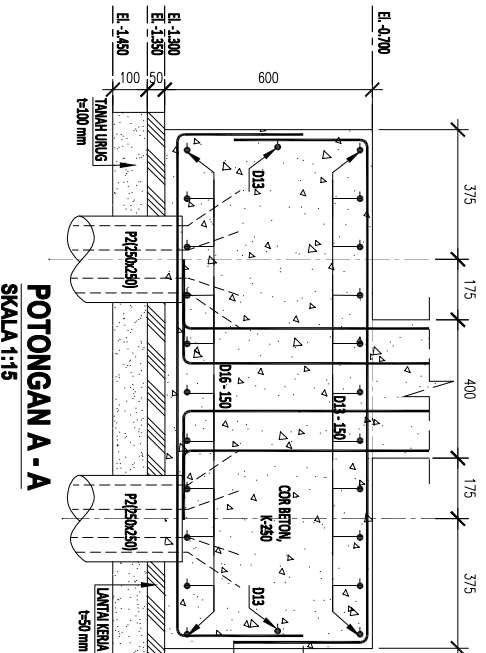

POTONGAN A - A
SKALA 1:15

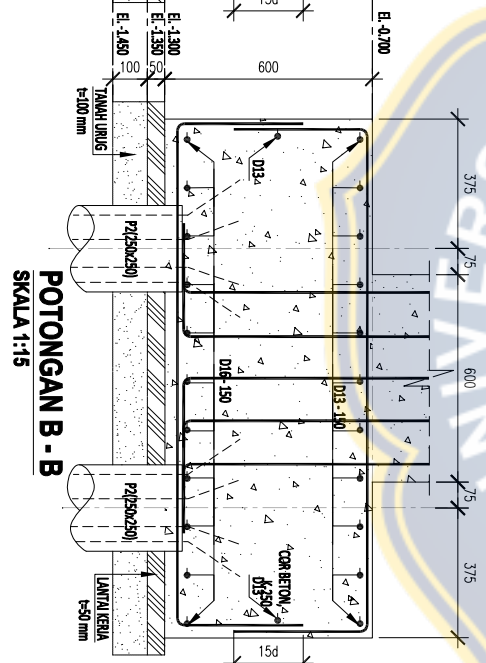

POTONGAN B - B
SKALA 1:15

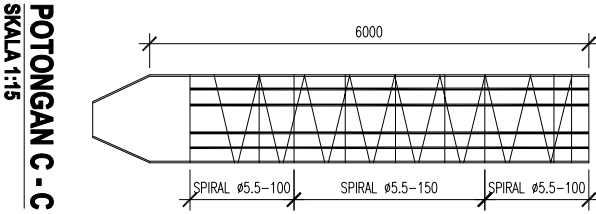

POTONGAN C - C
SKALA 1:15

NOTE
CONCRETE QUALITY:

BECON
PILE CAP, TIIE BEAM = K-250
COLUMN, BEAM, SLAB = K-250
BESI
ULUR BMD 40 (40S20M)
POLUS BMT 24 (24) (F10)

DATE: 22-01-2019
PROJECT: PERBAKAMAN DIRUNTAI TONJ & KET

PROJECT SUPERVISION CONSULTANT

PT. HUTAJAYA KARYA - PT. NINDYA KARYA (CV)
APPROVED BY: DATE: SIGN:
CHECKED BY: DATE: SIGN:
DRAWN: DATE: SIGN:

SHOP DRAWING
DRAWING GROUP
TRAINING CENTER

DIVISION
STRUKTUR
DRAWING TITLE

DETAIL PILE CAP PC-4
SCALE: 1:15
SHEET: 8
DRAWING NO: S037M01.0030

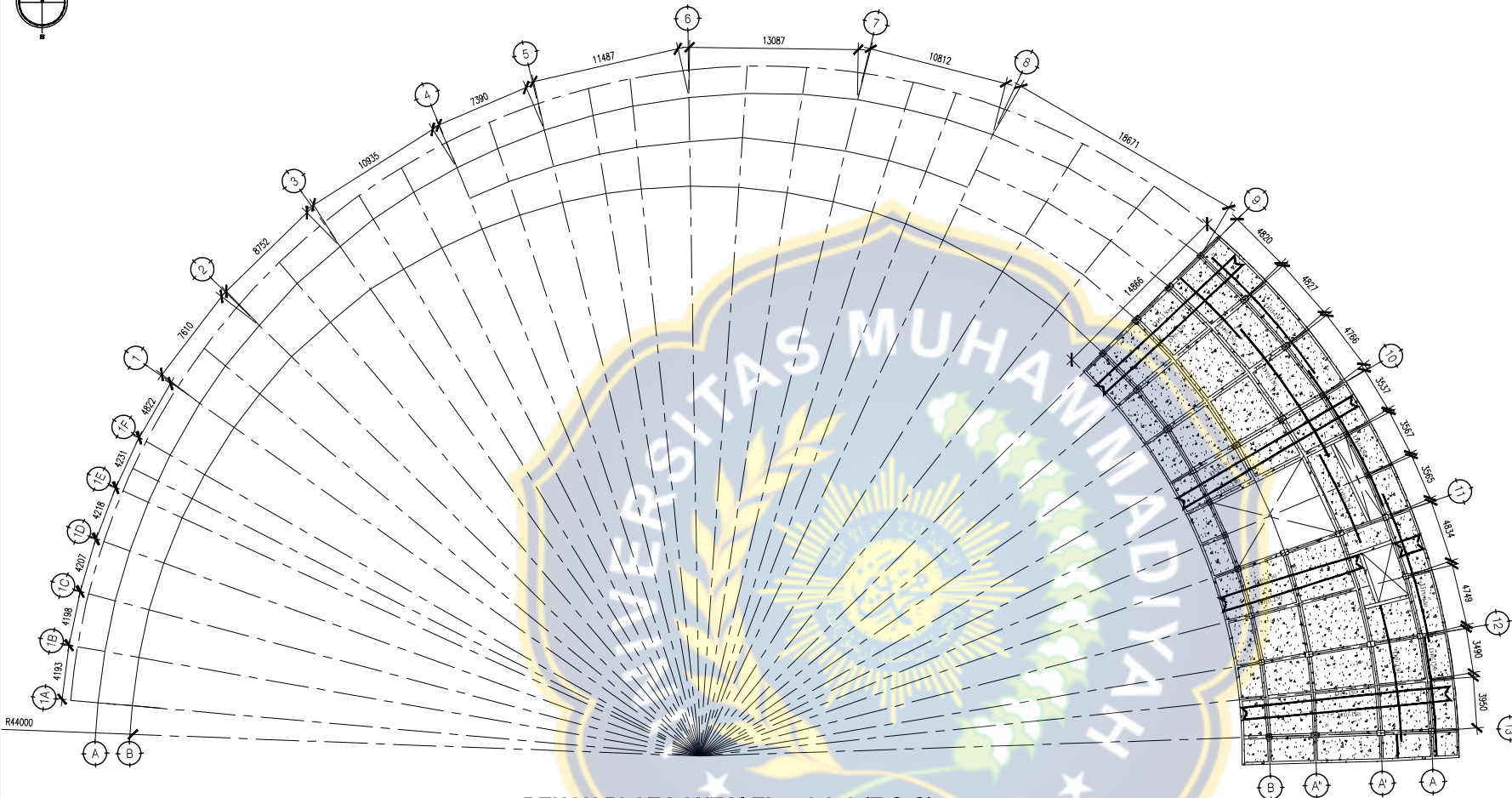

DENAH PLAT LANTAI EL. +4.450 (T.O.C)
SKALA 1:350

NOTE

CONCRETE QUALITY :

- BETON**
- PILECAP, TIE BEAM = K-250
- COLUMN, BEAM, SLAB = K-250
- BESI**
- ULIR BJTD 40 U40 (DEFORM)
- POLOS BJTP 24 U24 (PLIN)

DATE	REVISION

PROJECT

THE CONSTRUCTION OF INTEGRATED LABORATORIES, AGROTECHNOPARK COMPLEX, AND AUDITORIUM OF THE UNIVERSITY OF JEMBER

PROJECT SUPERVISION CONSULTANT

ENYER, JAVI & KUNING, SINGAMBARU & WIJAYA KIP, JGG

TEAM LEADER	DATE	SIGN
TRIVINDO ANDIPUTRA, ST, M.Eng		

TRIVINDO ANDIPUTRA, ST, M.Eng

CONTRACTOR

ENYER, JAVI & KUNING, SINGAMBARU & WIJAYA KIP, JGG

PT. HUTAMA KARYA - PT. NINDYA KARYA (JV)

APPROVED BY	DATE	SIGN
M. PRIATMOKO, ST PM		
WAHYUDI, ST DPM		
AINUN TWIFIANI, ST SEM		
TIKA NUR VIDYANI, ST SEM		

M. PRIATMOKO, ST

WAHYUDI, ST

AINUN TWIFIANI, ST

TIKA NUR VIDYANI, ST

DRAWN	DATE	SIGN
B. O. W. O Drafter		

B. O. W. O

SHOP DRAWING

DRAWING GROUP

TRAINING CENTER

DIVISION

STRUKTUR

DRAWING TITLE

DENAH BALOK EL. +4.450 (T.O.C)

SCALE	SHEET	DRAWING NO
1 : 350	1	2

SD.STR.01.007

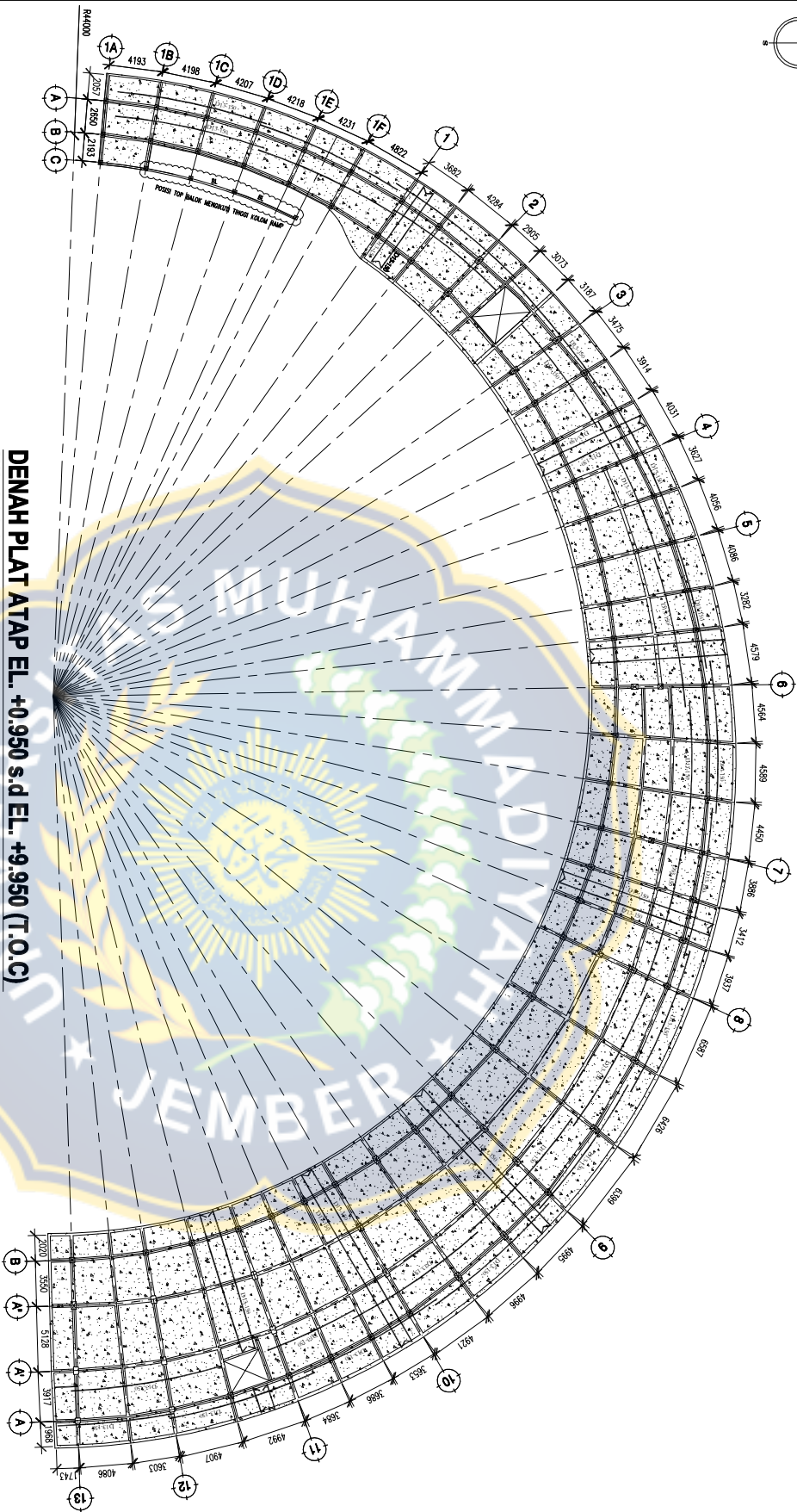

DENAH PLAT ATAP EL. +0.950 s.d EL. +9.950 (T.O.C)
SKALA 1:350

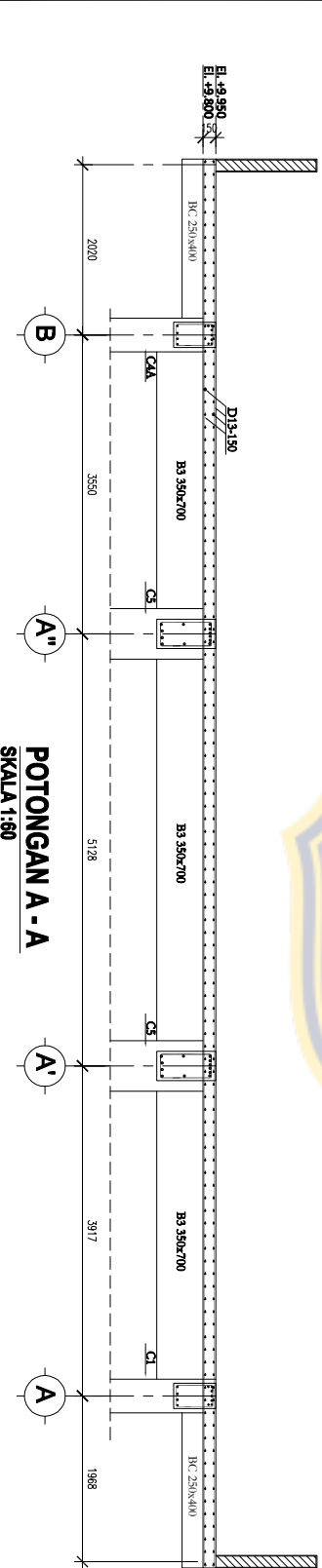

POTONGAN A - A
SKALA 1:60

NOTE	
CONCRETE QUALITY :	
BECON	PIECAP, THE BEAM = K-250
	COLUMN, BEAM, SLAB = K-250
	RESI
	LIMB BUD 40 U40 (DEFORM)
	POLOS BHP 24 U24 (RUM)
<p>THE CONSTRUCTION OF INTEGRATED LEARNING CENTER FOR THE STUDENTS AND ADMINISTRATOR OF THE UNIVERSITY OF JEMBER</p>	
PROJECT SUPERVISION CONSULTANT	
<p>PT. MUHAMMADIYAH ENGINEERING & ARCHITECTURE</p>	
TRIAL ENGINEER	DATE SIGN
DRAWN/DESIGNED/SCALE	DATE SIGN
CONTRACTOR	
<p>PT. MUTIARA KARYA - PT. NINDYA KARYA (CV)</p>	
APPROVED BY	DATE SIGN
MANAGER/PROJECT	DATE SIGN
CHECKED BY	DATE SIGN
DRAWN	DATE SIGN
R.O.M.O	DATE SIGN

SHOP DRAWING

DRAWING GROUP
 TRAINING CENTER
 DIVISION
STRUKTUR
 DRAWING TITLE

DENA PLAT ATAP			
EL. +0.950 s.d EL. +9.950 (T.O.C)			
SCALE	SHEET	DRAWING NO	
1:350	1	903/STR/212	

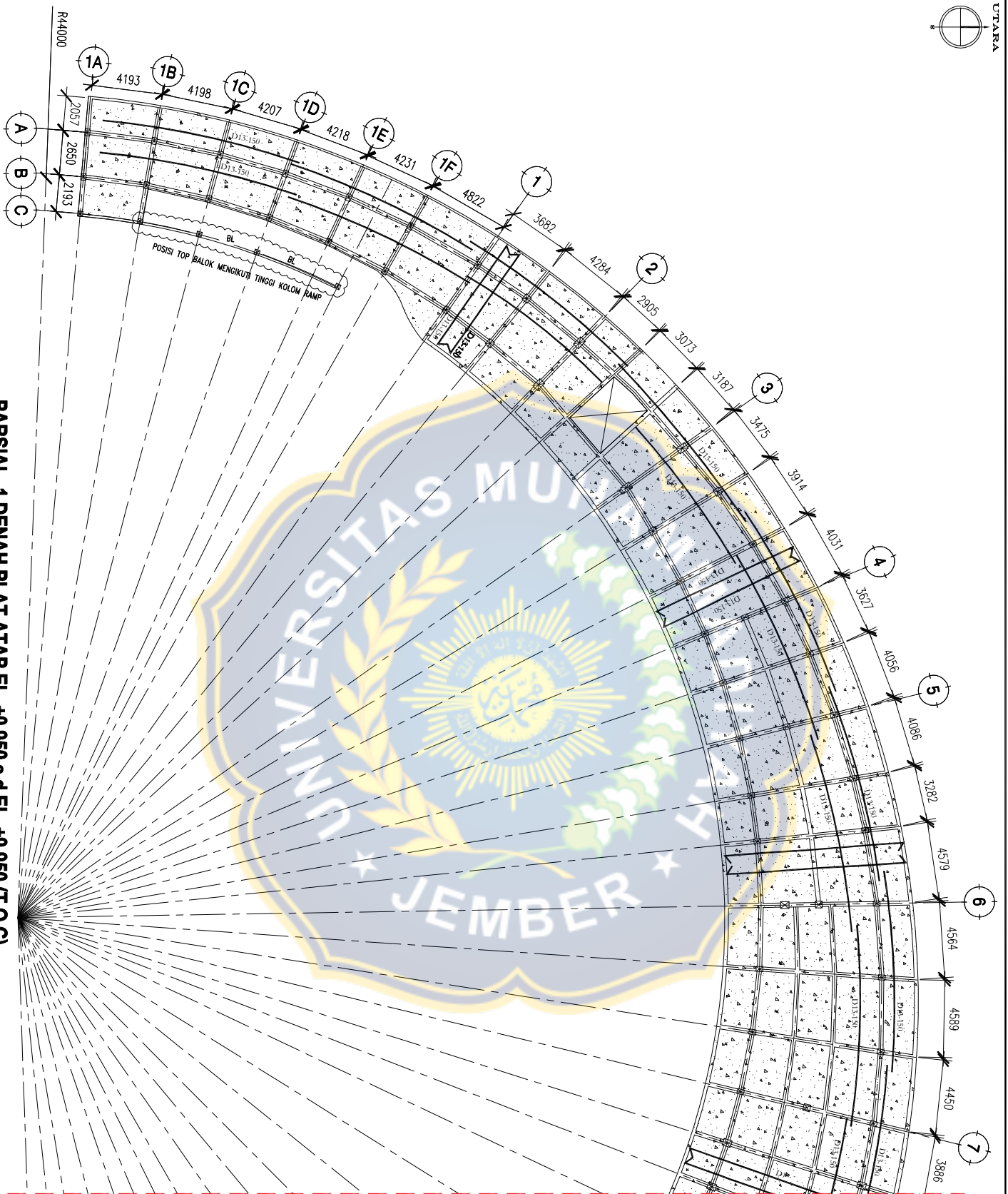

PARSIAL -1 DENAH PLAT ATAP EL. +0.950 s.d EL. +9.950 (T.O.C)
SKALA 1:220

NOTE

CONCRETE QUANTITY:
 BECON
 R/C SLAB, THE BEAM = K-250
 COLUMN, BEAM, SLAB = K-250
 RESI
 LUM BUND 40 UAG (DEFORM)
 POLUS BTP 24 U24 (RUM)

REVISION

DATE	REVISION

PROJECT

THE CONSTRUCTION OF INTEGRATED
 LEARNING CENTER FOR THE
 AND AUDITORIUM OF THE UNIVERSITY OF JEMBER

PROJECT SUPERVISION CONSULTANT

PT. MUTIARA KARYA - PT. NINDYA KARYA
 (CV)

CONTRACTOR

PT. MUTIARA KARYA - PT. NINDYA KARYA
 (CV)

APPROVED BY: DATE: SIGN:

CHANGED BY: DATE: SIGN:

DRAWN: DATE: SIGN:

SHOP DRAWING

DRAWING GROUP
 TRAINING CENTER
 DIVISION
STRUKTUR
 DRAWING TITLE

PARSIAL -1 DENAH PLAT ATAP

SCALE SHEET DRAWING NO
 1:220 2 3 S03TR01/1/24

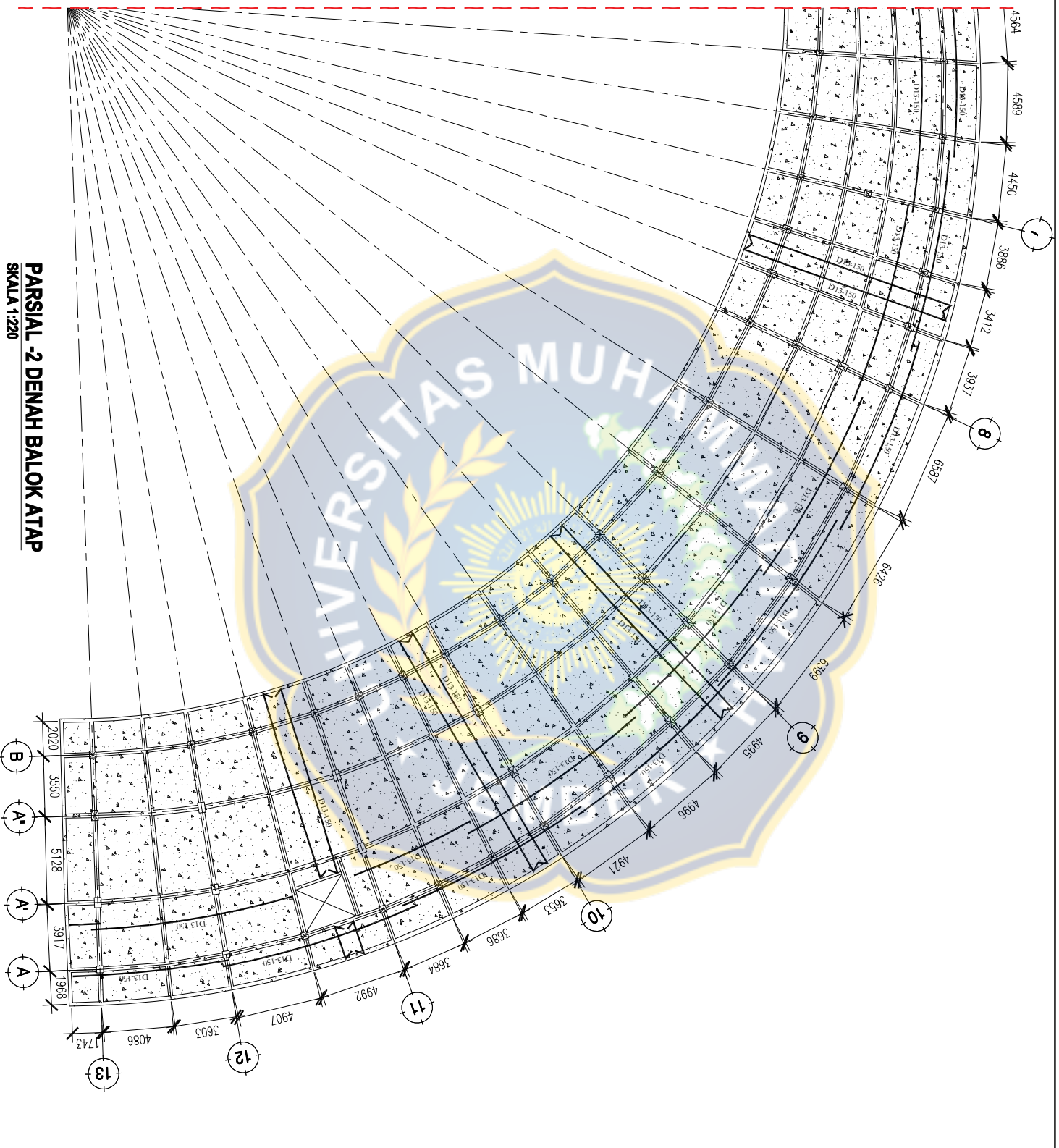

PARSIAL-2 DENAH BALOK ATAP
SKALA 1:220

NOTE

CONCRETE QUANTITY:
 BECON
 PILECAP, THE BEAM = K-250
 COLUMN, BEAM, SLAB = K-250
 RESI
 LUKLUR BILD 40 UMB (BERFORM)
 POLUS BIMP 24 U24 (RUM)

DATE	REVISION

THE CONSTRUCTION OF INTEGRATED
 LAMPUNG UNIVERSITY OF TECHNOLOGY
 AND AGRICULTURE OF THE UNIVERSITY OF JEMBER

PROJECT SUPERVISION CONSULTANT

ENGINEER/ARCHITECT/STRUCTURAL ENGINEER
 PT. MUTIARA KARYA - PT. NINDYA KARYA
 (CV)

CONTRACTOR

APPROVED BY	DATE	SIKIL
M. PRATIWI		
M. PRATIWI		

CHANGED BY	DATE	SIKIL

DRAWING	DATE	SIKIL

SHOP DRAWING

DRAWING GROUP
 TRAINING CENTER
 DIVISION
STRUKTUR
 DRAWING TITLE

SCALE	SHEET	DRAWING NO
1:220	3	8037041/028

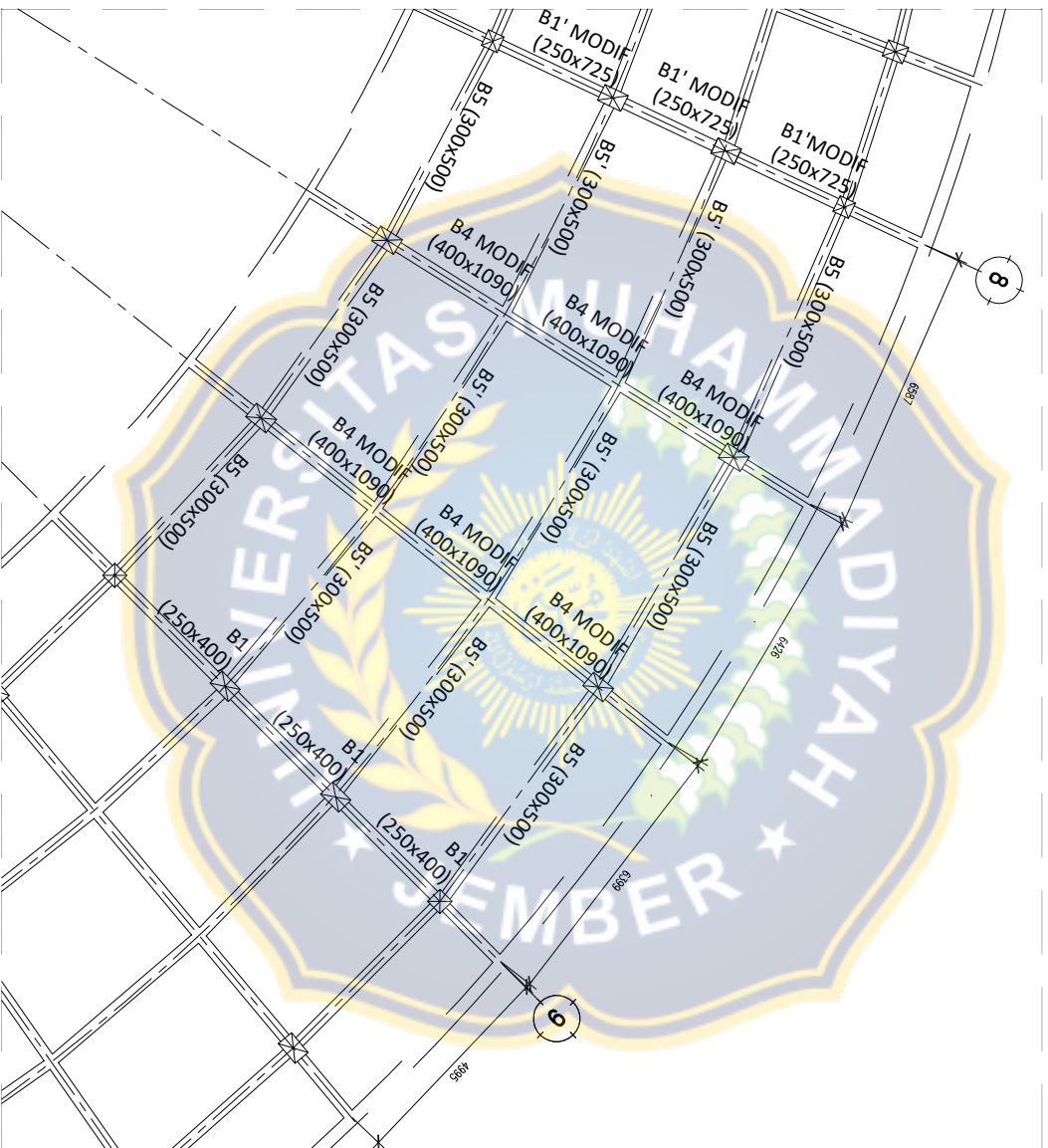
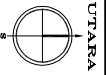

DENAH BALOK ATAP LINE 8 s.d 9
SKALA 1:120

NOTE

CONCRETE QUANTITY :

BECON
 PILECAP, THE BEAM = K-250
 COLUMN, BEAM, SLAB = K-250
 BESI
 LUKER BAJU 40 UJUK (BERFORM)
 POLUS BTP 24 U24 (RUM)

REVISION

DATE PROJECT

THE CONSTRUCTION OF INTEGRATED
 LABORATORY FOR THE STUDY OF
 AND AUDITORIUM OF THE UNIVERSITY OF JEMBER

PROJECT SUPERVISION CONSULTANT

CONTRACTOR

PT. HUTAJAYA KARYA - PT. NINDYA KARYA (CV)

SHOP DRAWING

DRAWING GROUP
 TRAINING CENTER
 DIVISION
STRUKTUR
 DRAWING TITLE

SCALE	1:120
SHEET	1
DRAWING NO	8
DATE	2023/03/29/2024

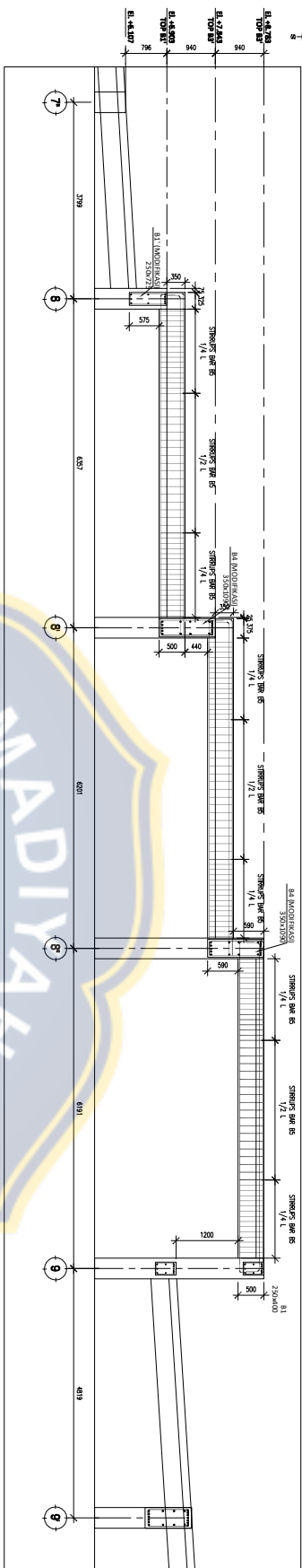

TABEL PENULANGAN RE-BAR BALOK

TYPE	B1		B1 MODIFIKASI		TYPE	B4 MODIFIKASI		TYPE	B5		B5'	
	DIMENSI	TUMPUKAN	LAPANGAN	TUMPUKAN		LAPANGAN	DIMENSI		TUMPUKAN	LAPANGAN	TUMPUKAN	LAPANGAN
TOP MAIN BAR	5-D16	3-D16	5-D16	3-D16	400x1090	400x1090	400x1090	7-D16	4-D16	6-D16	3-D16	3-D16
BOIT MAIN BAR	3-D16	5-D16	3-D16	5-D16	6-D19	6-D19	6-D19	4-D16	7-D16	3-D16	6-D16	6-D16
STRIRRUPS BAR	D10-100	D10-150	D10-100	D10-100	D10-100	D10-150	D10-150	D10-100	D10-150	D10-100	D10-150	D10-150
WIDE BAR	2-D13	2-D13	2-D13	2-D13	4-D13	4-D13	4-D13	-	-	-	-	-

NOTE

CONCRETE QUANTITY
 BECON
 PILECAP, THE BEAM = K-250
 COLUMN, BEAM, SLAB = K-250
 RESI
 LUB LUB 40 (BEFON)
 POLS BHP 24 (24 (RM))

REVISION

PROJECT

THE CONSTRUCTION OF INTEGRATED
 LABORATORY AND OFFICE BUILDING
 AND AUDITORIUM OF THE UNIVERSITY OF JEMBER

PROJECT SUPERVISION CONSULTANT

ENGINEER/ARCHITECT/STRUCTURAL ENGINEER
 PT. HUTAJAYA KARYA - PT. NINDYA KARYA
 (CV)

CONTRACTOR

APPROVED BY DATE SIGN

CHECKED BY DATE SIGN

DATE SIGN

DATE SIGN

DATE SIGN

DRAWING GROUP
 TRAINING CENTER

DIVISION
 STRUKTUR

DRAWING TITLE
 DETAIL PENULANGAN BALOK LINE 8 s.d 9
 SCALE SHEET DRAWING NO
 1:90 2 8 S03R01/01/04

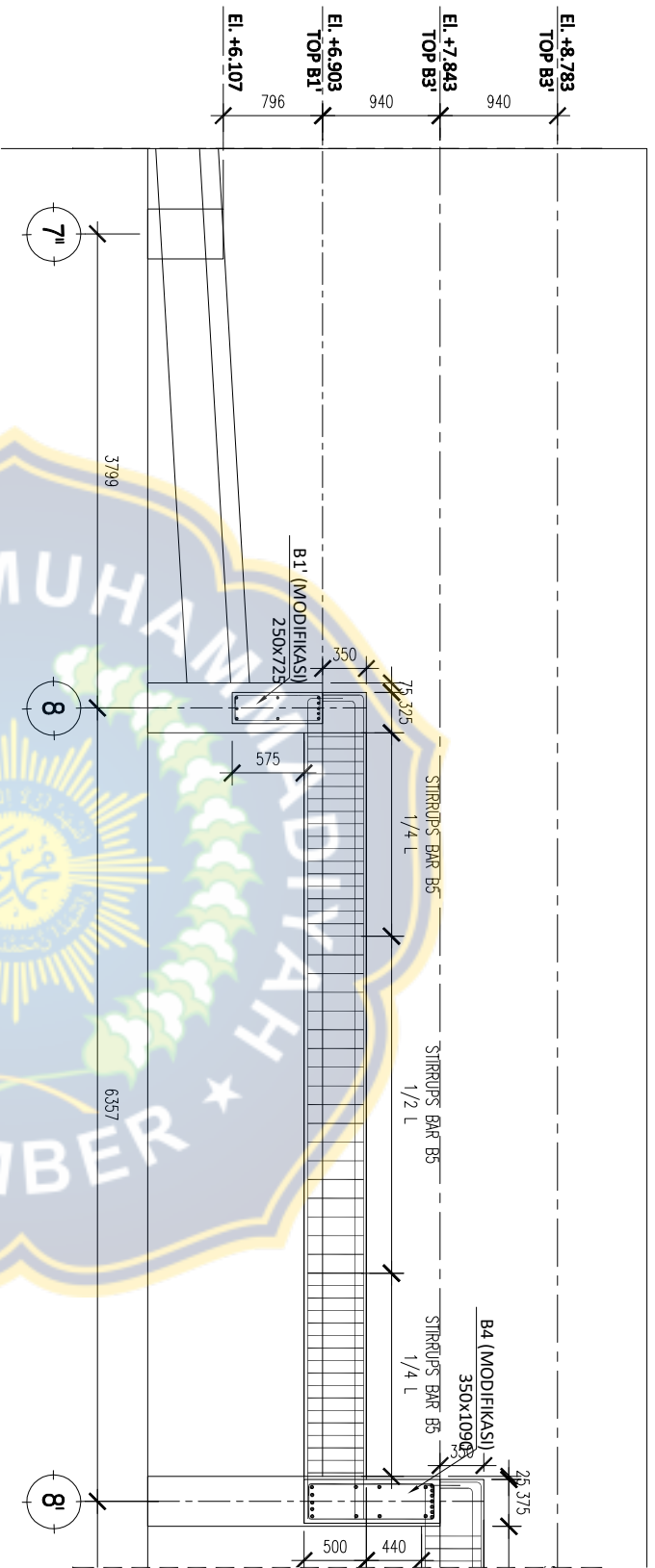

PARSIAL -1 DETAIL PENULANGAN BALOK LINE 8 s.d 9
SKALA 1:45

TABEL PENULANGAN RE-BAR BALOK

TYPE	B1		B1' MODIFIKASI	
	250x400	250x400	250x725	250x725
DIMENSI	TUNPUN	LAPANGAN	TUNPUN	LAPANGAN
TOP MAIN BAR	5-D16	3-D16	5-D16	3-D16
BOTT MAIN BAR	3-D16	5-D16	3-D16	5-D16
STRIRRUPS BAR	D10-100	D10-150	D10-100	D10-100
WIDE BAR	2-D13	2-D13	2-D13	2-D13

TYPE	B4 MODIFIKASI	
	400x1090	400x1090
DIMENSI	TUNPUN	LAPANGAN
TOP MAIN BAR	9-D19	6-D19
BOTT MAIN BAR	6-D19	9-D19
STRIRRUPS BAR	D10-100	D10-150
WIDE BAR	4-D13	4-D13

TYPE	B5		B5	
	300x500	300x500	300x300	300x300
DIMENSI	TUNPUN	LAPANGAN	TUNPUN	LAPANGAN
TOP MAIN BAR	7-D16	4-D16	6-D16	3-D16
BOTT MAIN BAR	4-D16	7-D16	3-D16	6-D16
STRIRRUPS BAR	D10-100	D10-150	D10-100	D10-150
WIDE BAR	-	-	-	-

NOTE

CONCRETE QUANTITY:
 BLOK
 PILECAP, THE BEAM = K-250
 COLUMN, BEAM, SLAB = K-250
 BESI
 LUKA BIRD 40 UMB (DEFROM)
 POLUS BTP 24 U24 (RUM)

DATE	REVISION

THE CONSTRUCTION OF INTEGRATED
 LABORATORY FOR THE STUDENT OF CIVIL
 AND ARCHITECTURE OF THE UNIVERSITY OF JEMBER

PROJECT SUPERVISION CONSULTANT

ENGINEER: KIKI LUCIANA SUGANDHA VIBHA PERBISA

TEAM LEADER	DATE	SIKSI

CONTRACTOR

PT. UTARAYA KARYA - PT. NINDYA KARYA (CV)

APPROVED BY	DATE	SIKSI

CHANGED BY	DATE	SIKSI

DRAWING	DATE	SIKSI

SHOP DRAWING

DRAWING GROUP
 TRAINING CENTER

DIVISION
STRUKTUR
 DRAWING TITLE
 PARSIAL -1
 DETAIL PENULANGAN BALOK LINE 8 s.d 9
 SCALE
 SHEET 3 8
 DRAWING NO
 S03TR04/1988

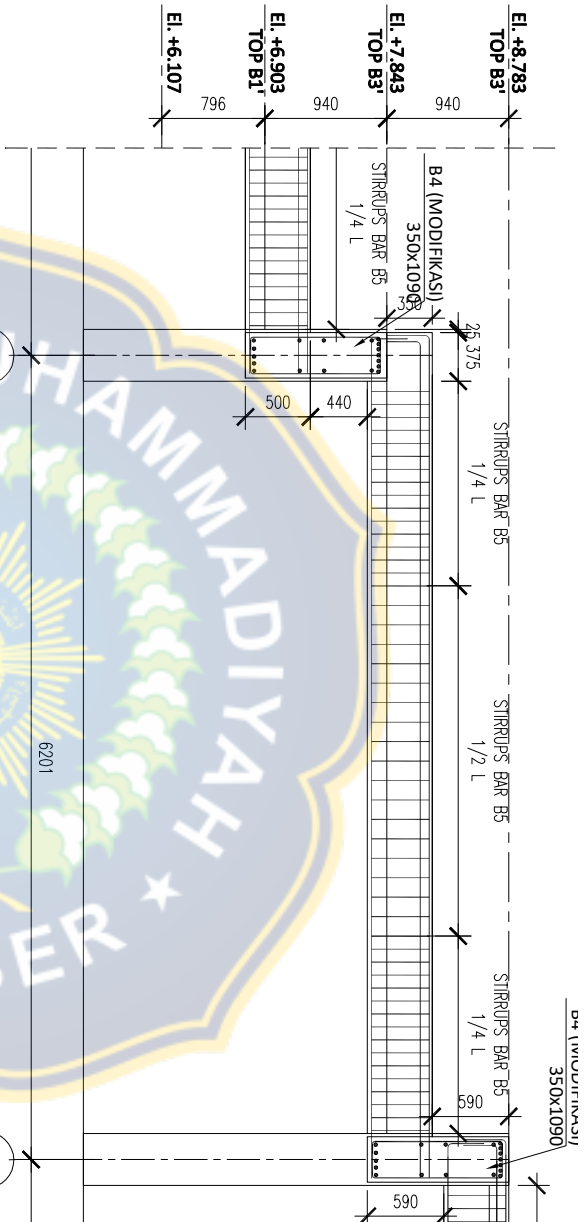

PARSIAL -2 DETAIL PENULANGAN BALOK LINE 8 s.d 9
SKALA 1:45

TABEL PENULANGAN RE-BAR BALOK

TYPE	B1		B1 MODIFIKASI		TYPE	B4 MODIFIKASI		B5		B5		
	250x400	250x400	250x725	250x725		400x1090	400x1090	300x500	300x500	300x500	300x500	
DIMENSI	TUNPUN	LAPANGAN	TUNPUN	LAPANGAN	TUNPUN	LAPANGAN	TUNPUN	LAPANGAN	TUNPUN	LAPANGAN	TUNPUN	LAPANGAN
TOP MAIN BAR	5-D16	3-D16	5-D16	3-D16	9-D19	6-D19	7-D16	4-D16	6-D16	3-D16	3-D16	6-D16
BOTT MAIN BAR	3-D16	5-D16	3-D16	5-D16	6-D19	9-D19	4-D16	7-D16	4-D16	3-D16	6-D16	3-D16
STIRRUPS BAR	D10-100	D10-150	D10-100	D10-100	D10-100	D10-150	D10-100	D10-150	D10-100	D10-100	D10-150	D10-150
WIDE BAR	2-D13	2-D13	2-D13	2-D13	4-D13	4-D13	-	-	-	-	-	-

NOTE

CONCRETE QUANTITY:
 BECON
 PIECEUP THE BEAM = K-250
 COLUMN, BEAM, SLAB = K-250
 RESI
 LUKA BUD 40 UAH (DEFROM)
 POLIS BTP 24 UZ (RUB)

REVISION

DATE PROJECT

THE CONSTRUCTION OF INTEGRATED
 LABORATORY BUILDING FOR THE
 AND ACADEMIC OF THE UNIVERSITY OF JEMBER

PROJECT SUPERVISION CONSULTANT

ENGINEER: H. KURNIAWAN S.P., M.P.A., M.Eng.
 PT. NINDYA KARYA (CV)

CONTRACTOR

PT. NINDYA KARYA - PT. NINDYA KARYA (CV)

APPROVED BY

DATE SIGN

DATE SIGN

DATE SIGN

DATE SIGN

DATE SIGN

DATE SIGN

SHOP DRAWING

DIVISION
 STRUKTUR
 DRAWING TITLE

DRAWING GROUP
 TRAINING CENTER

SCALE SHEET DRAWING NO
 1:200 4 8 803/01/19/20

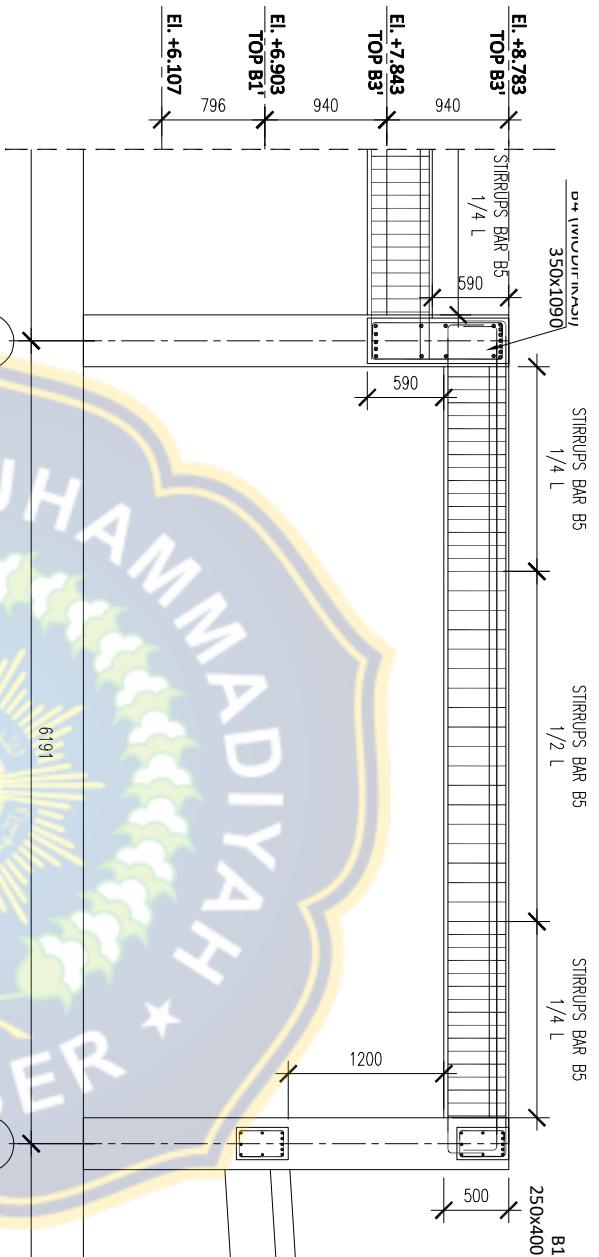

PARSIAL 3 DETAIL PENUNGGAN BALOK LINE 8 s.d 9
SKALA 1:45

TABEL PENUNGGAN RE-BAR BALOK

TYPE	B1		B1 MODIFIKASI		TYPE	B4 MODIFIKASI		TYPE	B5		TYPE	B5	
	DIMENSI	DIMENSI	DIMENSI	DIMENSI		DIMENSI	DIMENSI		DIMENSI	DIMENSI		DIMENSI	DIMENSI
TOP MAIN BAR	5-D16	3-D16	5-D16	3-D16	TOP MAIN BAR	9-D19	6-D19	TOP MAIN BAR	7-D16	4-D16	6-D16	3-D16	3-D16
BOTT MAIN BAR	3-D16	5-D16	3-D16	5-D16	BOTT MAIN BAR	6-D19	9-D19	BOTT MAIN BAR	4-D16	7-D16	3-D16	6-D16	6-D16
STIRRUPS BAR	D10-100	D10-150	D10-100	D10-100	STIRRUPS BAR	D10-100	D10-150	STIRRUPS BAR	D10-100	D10-150	D10-100	D10-150	D10-150
WIDE BAR	2-D13	2-D13	2-D13	2-D13	WIDE BAR	4-D13	4-D13	WIDE BAR	-	-	-	-	-

NOTE

CONCRETE QUANTITY:
BELOW
PIECES: THE BEAM = K-250
COLUMN, BEAM, SLAB = K-250
REIN
LINK BILD 40 (BELOW)
POLOS BHP 24 (24 (RUB))

REVISION

PROJECT

THE CONSTRUCTION OF INTEGRATED
LABORATORY FOR THE STUDENT OF
AND AROUND OF THE UNIVERSITY OF JEMBER

PROJECT SUPERVISION CONSULTANT

PT. MUTIARA KARYA - PT. NINDYA KARYA
(CV)

CONTRACTOR

APPROVED BY

APPROVED BY: DATE: SIGN:
M. PRADIPRANANTO
M. PRADIPRANANTO
M. PRADIPRANANTO
M. PRADIPRANANTO

CHANGED BY

CHANGED BY: DATE: SIGN:
M. PRADIPRANANTO
M. PRADIPRANANTO
M. PRADIPRANANTO
M. PRADIPRANANTO

DRAWING

DRAWING: DATE: SIGN:
R. D. M. D.
R. D. M. D.
R. D. M. D.
R. D. M. D.

SHOP DRAWING

DRAWING GROUP
TRAINING CENTER
DIVISION
STRUKTUR
DRAWING TITLE

DRAWING TITLE

SCALE

SHEET

DRAWING NO

DATE

BY

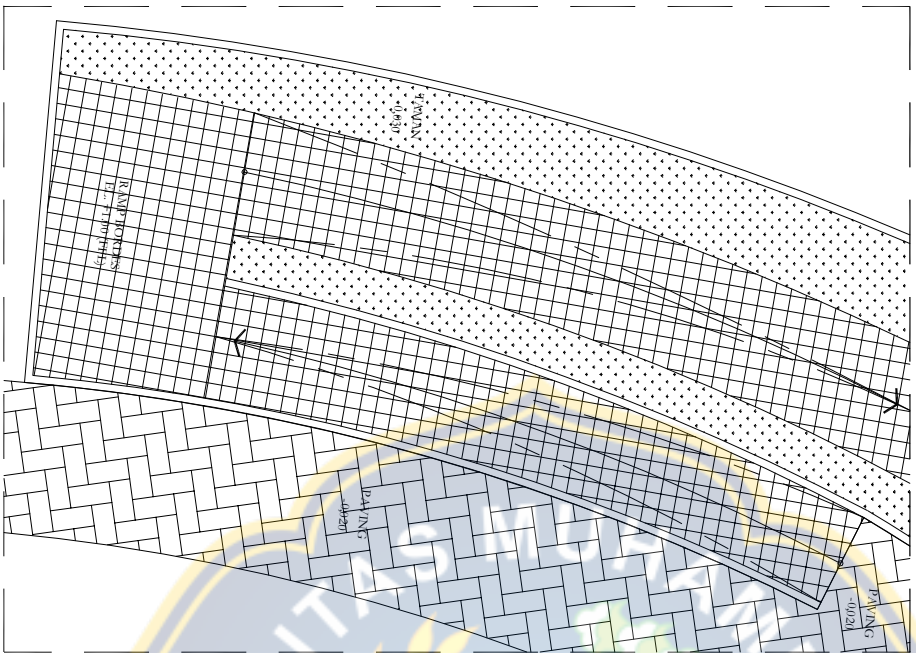

LAY-OUT RAMP
SKALA 1:100

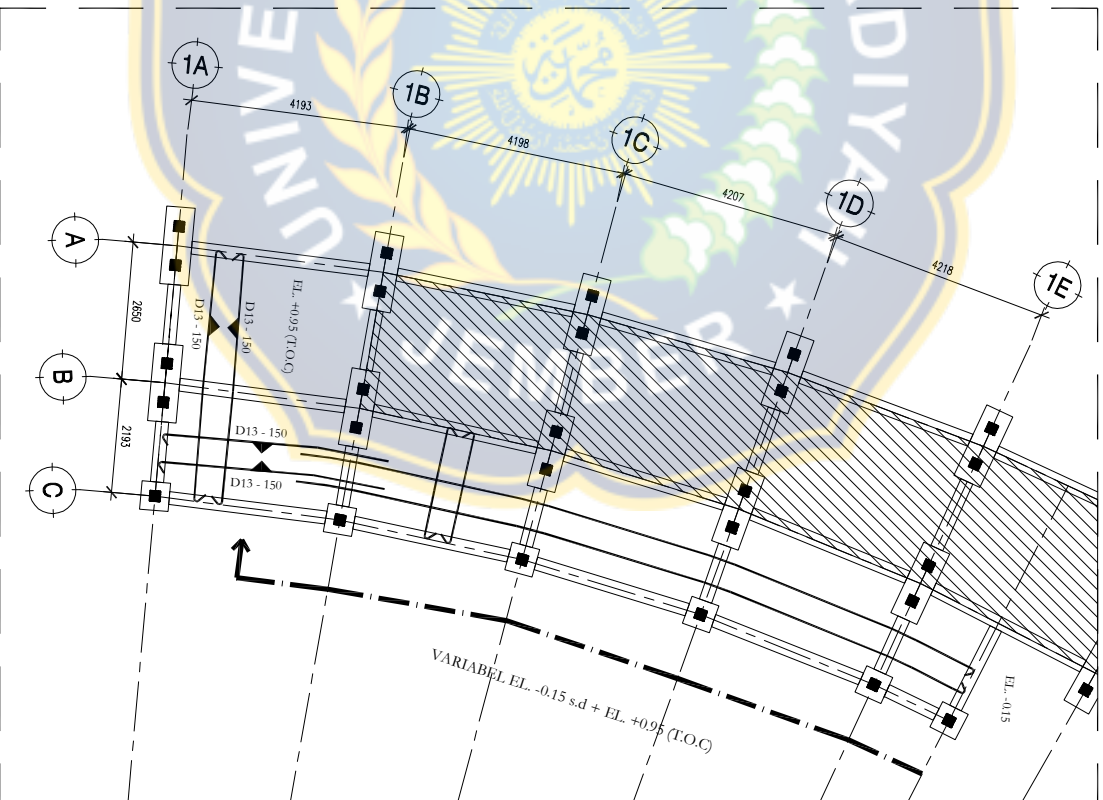

DETAIL RE-BAR PLAN RAMP
SKALA 1:100

NOTE

CONCRETE QUANTITY :

BECON
PIECAP, THE BEAM = K-250
COLUMN, BEAM, SLAB = K-250
RESI
LUM BUD 40 UAG (DEFROM)
POLIS BTP 24 U24 (RUM)

REVISION

PROJECT

THE CONSTRUCTION OF INTEGRATED
LAMPUNG SUPERIOR POLYTECHNIC
AND AUDITORIUM OF THE UNIVERSITY OF JAMBER

PROJECT SUPERVISION CONSULTANT

ENGINEER'S NAME: NUR SUGENAWATI PERBISA

TRIAL LABORER

INTERVENOR/MEASURER

CONTRACTOR

INDONESIA: KEMENTERIAN PENDIDIKAN DAN KEBUDAYAAN

PT. HUTAJAYA KARYA - PT. NINDYA KARYA (CV)

APPROVED BY: DATE: SIGN:

M. PRATIWI, S.T.

WALID, S.T.

CHECKED BY: DATE: SIGN:

AMANI, S.T.

YUSRI, S.T.

THEME/WORK/PROJECT

DRAWN: DATE: SIGN:

R.O.M. O

DATE: SIGN:

SHOP DRAWING

DRAWING GROUP
TRAINING CENTER

DIVISION

STRUKTUR

DRAWING TITLE

LAY-OUT & DETAIL RE-BAR PLAN RAMP

SCALE SHEET DRAWING NO

1:100 1 4 90.873/1.05

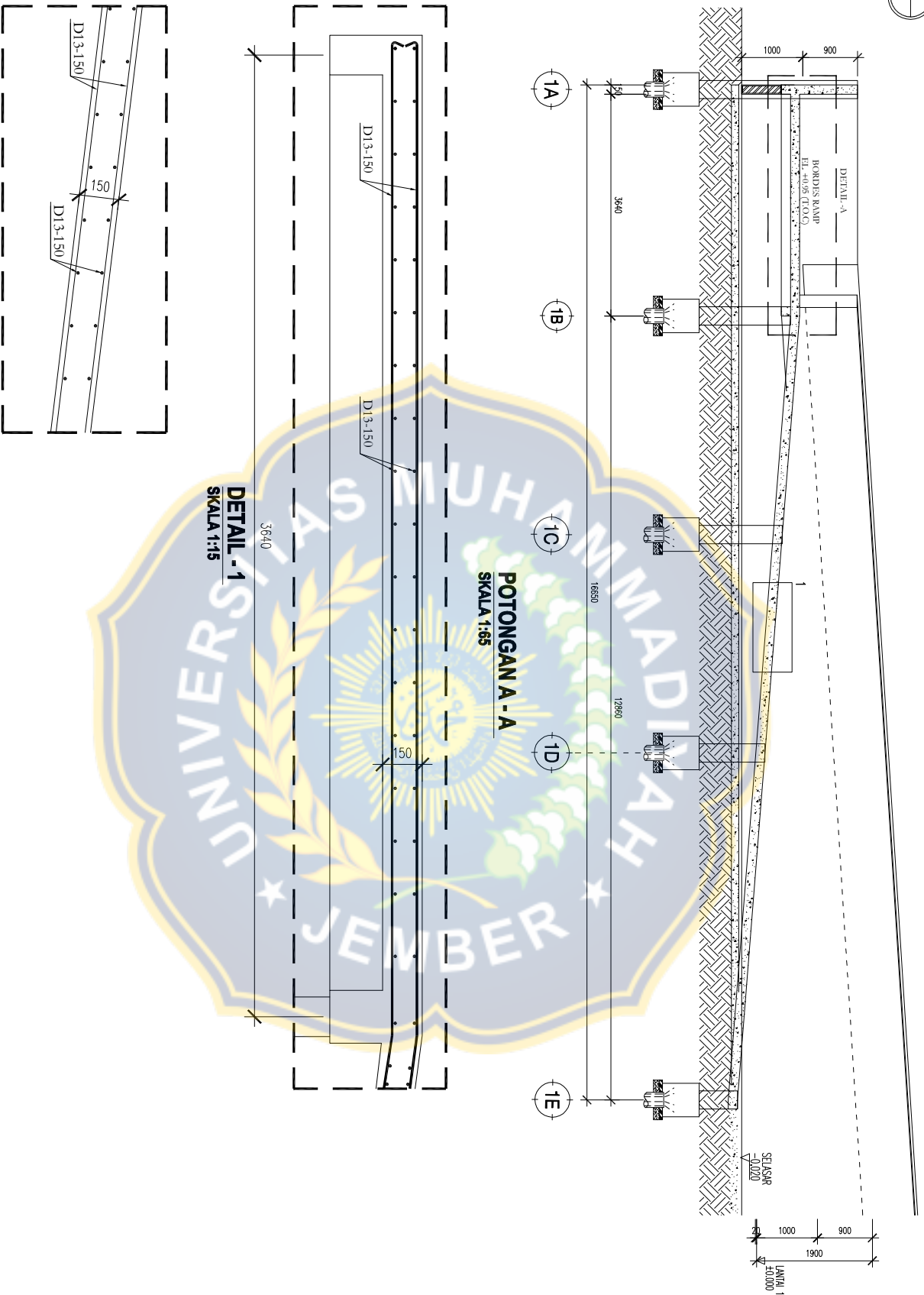

NOTE

CONCRETE QUANTITY:
 BEAM
 PIECEUP THE BEAM = K-250
 COLUMN, BEAM, SLAB = K-250
 BESI
 LUKU BUND 40 UMB (BERFORM)
 POLUS BHP 24 U24 (RUM)

REVISION

DATE PROJECT

THE CONSTRUCTION OF INTEGRATED
 LABORATORY BUILDING FOR
 AND AUDITORIUM OF THE UNIVERSITY OF JEMBER

PROJECT SUPERVISION CONSULTANT

PT. MUTIARA KARYA - PT. NINDYA KARYA
 (CV)

CONTRACTOR

PT. MUTIARA KARYA - PT. NINDYA KARYA
 (CV)

APPROVED BY

DATE SIGN
 DATE SIGN
 DATE SIGN

CHECKED BY

DATE SIGN
 DATE SIGN
 DATE SIGN

DRAWING TITLE

PARSIAL 2 DENAH THE BEAM

SCALE	SHEET	DRAWING NO
1:15	2	SBSTR01.0004

SHOP DRAWING

DRAWING GROUP
 DIVISION
 STRUKTUR
 TRAINING CENTER

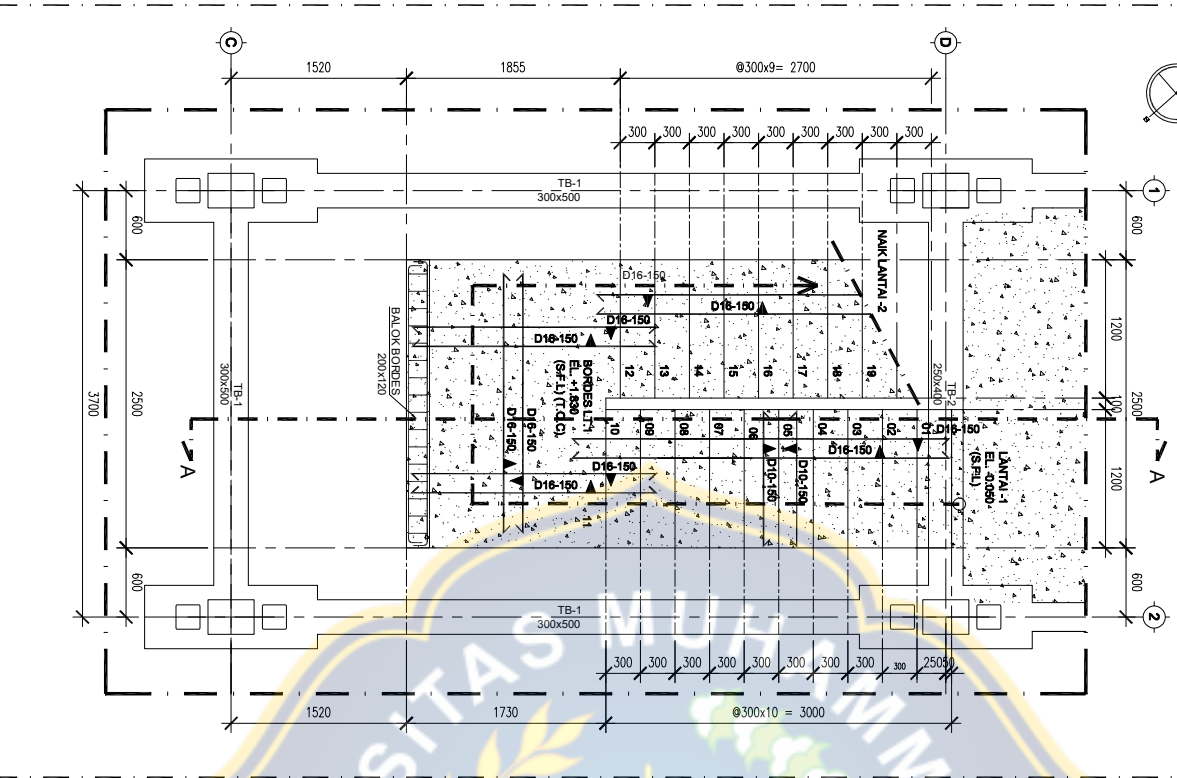

DETAIL TANGGA A LANTAI 1 (EL. -0.050) KE LANTAI 2 (EL. +3.550)
SKALA 1:50

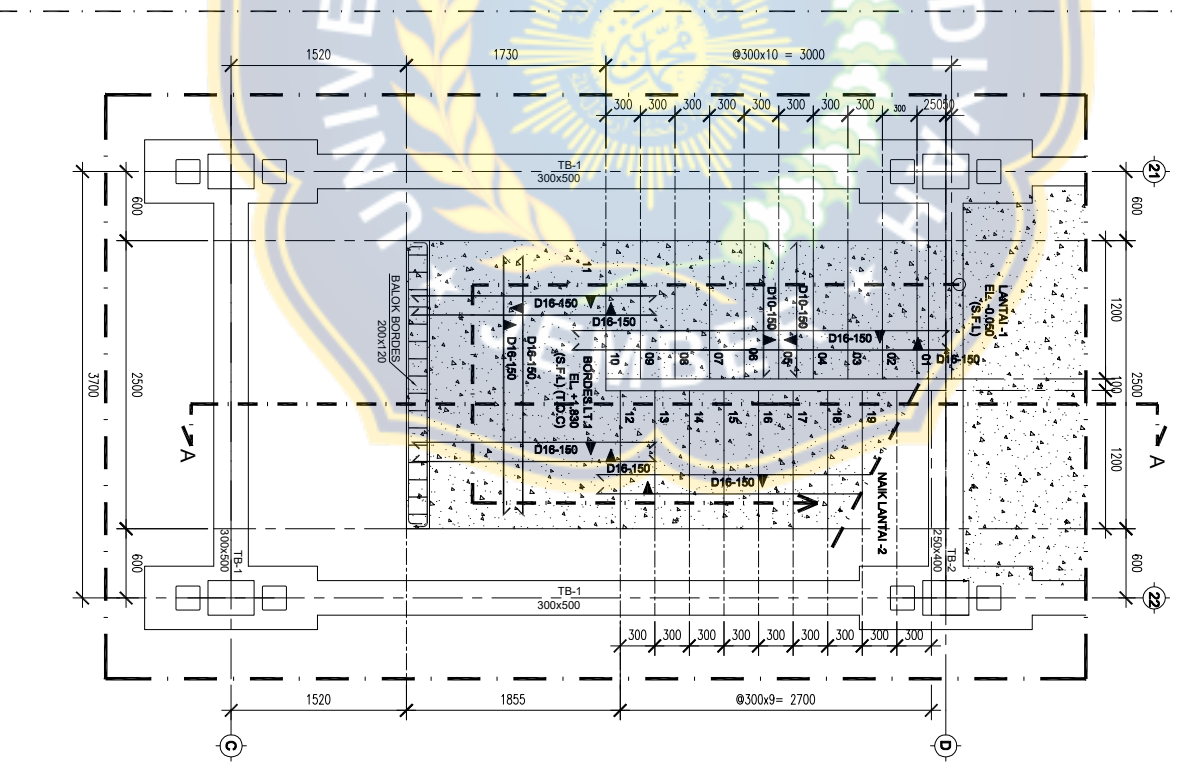

DETAIL TANGGA B LANTAI 1 (EL. -0.050) KE LANTAI 2 (EL. +3.550)
SKALA 1:50

NOTE

1. RUCUN, PERMITS, DAN SUDUT KONSULTASI
 2. RUCUN, PERMITS, DAN SUDUT KONSULTASI
 3. RUCUN, PERMITS, DAN SUDUT KONSULTASI
 4. RUCUN, PERMITS, DAN SUDUT KONSULTASI

REVISION

NO.	REVISION	DATE

PROJECT SUPERVISION CONSULTANT

PT. NATALIA KARYA - PT. NINDYA KARYA (CV)

CONTRACTOR

SHOP DRAWING

DRAWING GROUP
 TRAINING CENTER

STRUKTUR

NO.	REVISION	DATE

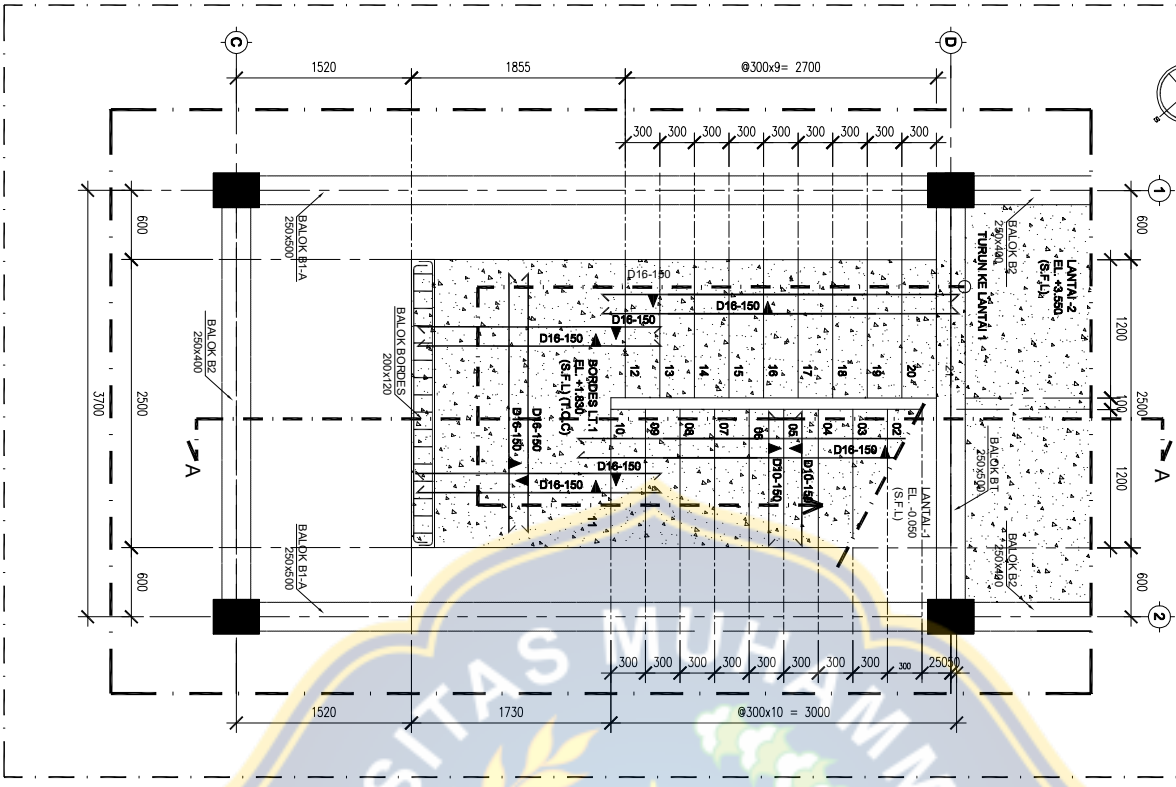

DETAIL TANGGA A LANTAI 2 (EL. +3.550) KE LANTAI 1 (EL. -0.050)
SKALA 1:50

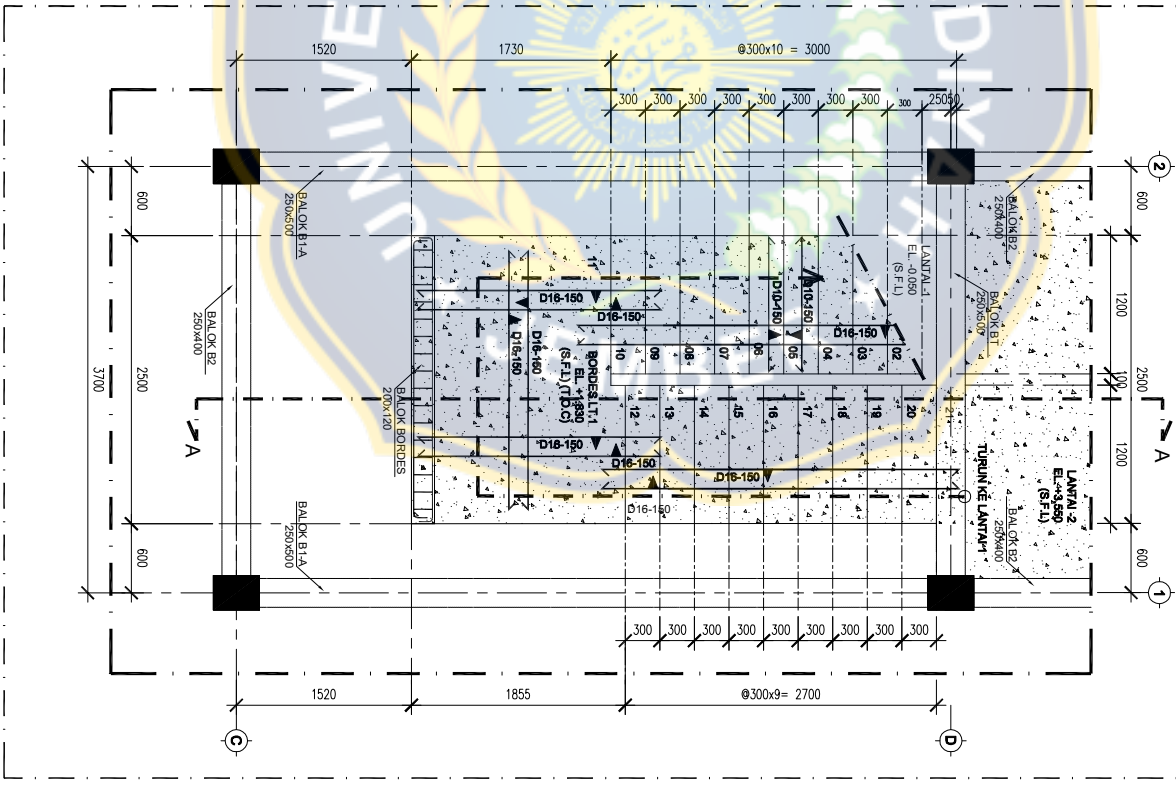

DETAIL TANGGA B LANTAI 2 (EL. +3.550) KE LANTAI 1 (EL. -0.050)
SKALA 1:50

NOTE

- 1. F.T. = 25.25.2016
- 2. F.T. = 25.25.2016
- 3. F.T. = 25.25.2016
- 4. F.T. = 25.25.2016
- 5. F.T. = 25.25.2016
- 6. F.T. = 25.25.2016
- 7. F.T. = 25.25.2016
- 8. F.T. = 25.25.2016
- 9. F.T. = 25.25.2016
- 10. F.T. = 25.25.2016

DATE	REVISION

PROJECT

THE CONSTRUCTION OF INTEGRATED LABORATORY BUILDING FOR THE FACULTY OF ENGINEERING AND ARCHITECTURE OF THE UNIVERSITY OF JEMBER

PROJECT SUPERVISION CONSULTANT

PT. NINDYA KARYA

TEAM MEMBER	DATE	SIGN

CONTRACTOR

PT. NINDYA KARYA

APPROVED BY	DATE	SIGN

CHANGED BY	DATE	SIGN

SHOP DRAWING

DRAWING GROUP
 TRAINING CENTER

DIVISION
STRUKTUR

DRAWING TITLE
 DETAIL TANGGA A & B
 LANTAI 2 (EL. +3.550) KE LANTAI 1 (EL. -0.050)

SCALE	SHEET	DRAWING NO
1:50	2	3

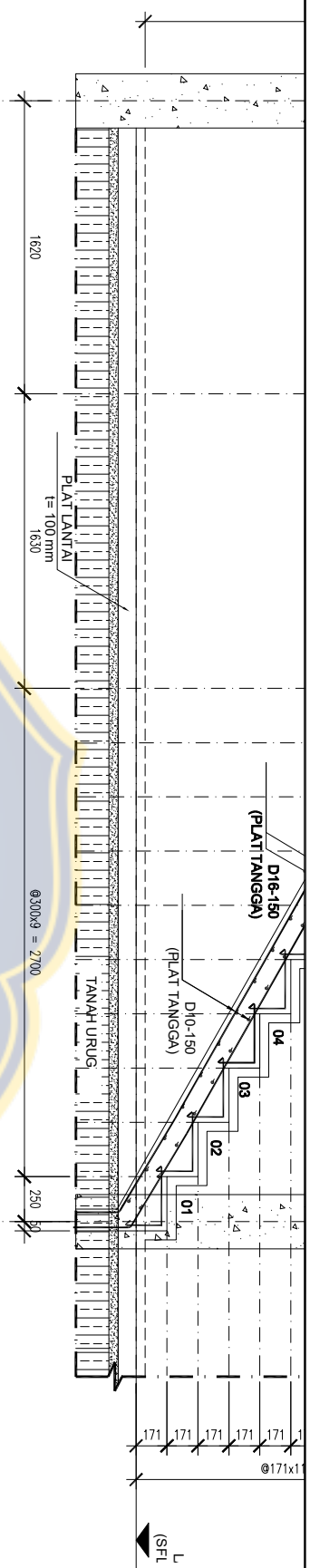

POTONGAN A - A
SKALA 1:25

NOTE
 1. F.T. = 37.50.000 / 1500
 2. F.T. = 20.50.000 / 1250
 3. F.T. = 20.50.000 / 1250
 4. S.101.171.024.000 / 1250
 5. S.101.171.024.000 / 1250

DATE	REVISION

THE CONSTRUCTION OF INTEGRATED LABORATORY FOR ENVIRONMENTAL AND ATMOSPHERIC OF THE UNIVERSITY OF JEMBER PROJECT SUPERVISION CONSULTANT	ERSALAH M. LAJALIAKOR DEWASALAKOR 10285
CONTRACTOR	PT. HUTAJAYA KARYA - PT. NINDYA KARYA (CV)
TEAM LEADER	DATE SIGN
DESIGNER	DATE SIGN
CHECKED BY	DATE SIGN
APPROVED BY	DATE SIGN

DRAWING GROUP TRAINING CENTER DIVISION STRUKTUR DRAWING TITLE POTONGAN A - A	SHOP DRAWING
---	---------------------

SCALE	1:25
SHEET	3
DRAWING NO	8030041285

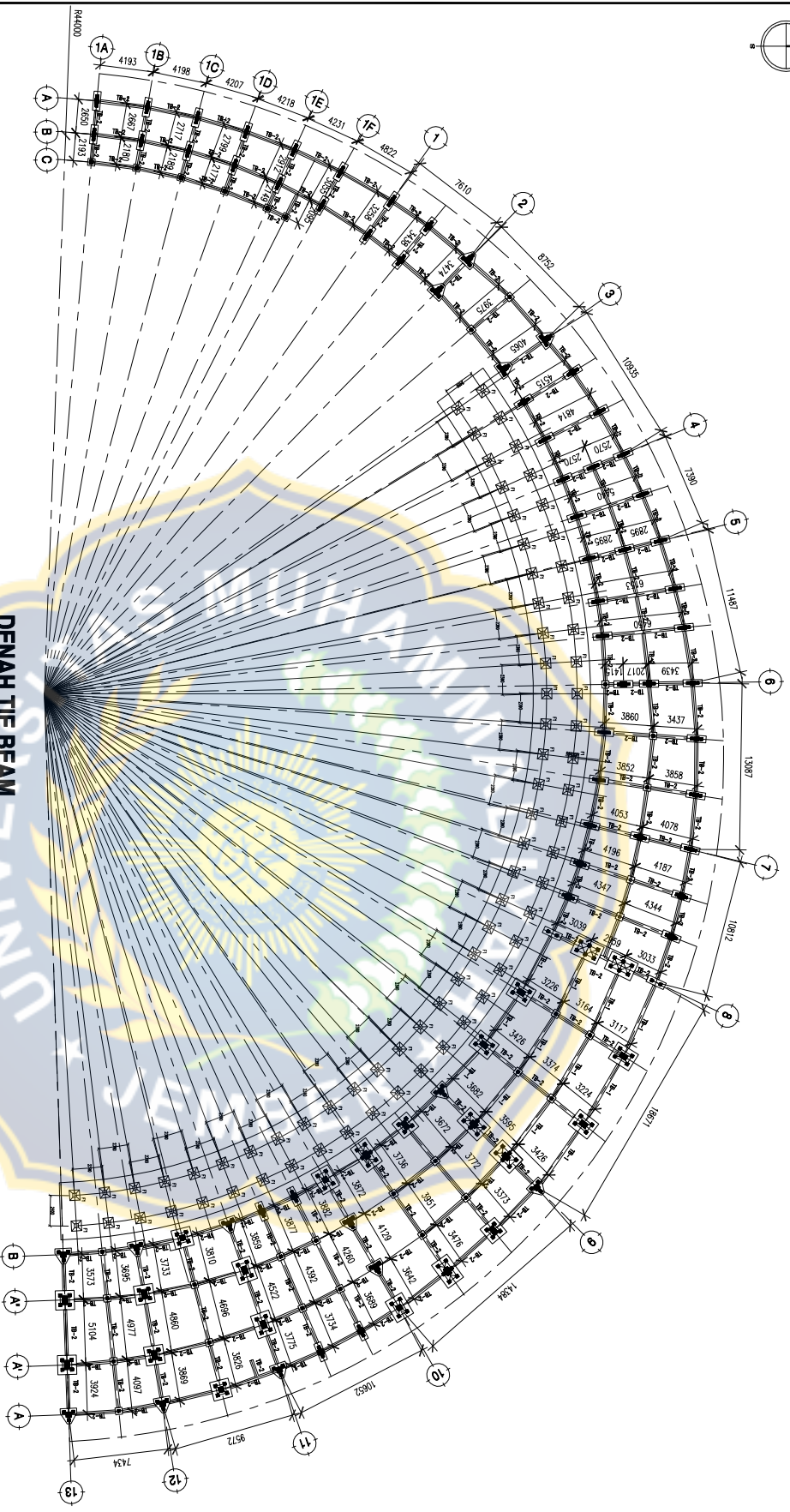

DENAH TIE BEAM
SKALA 1:350

TABEL PENJANGKANTIE BEAM

Tipe	Tipe 1	Tipe 2
Dimensi	250/300	250/400
Titik-titik	LAMANGAN	LAMANGAN
Top	250 500	250 500
Bottom	4.D16 D10-150	4.D16 D10-150
Struktur	4.D16 D10-150	4.D16 D10-150

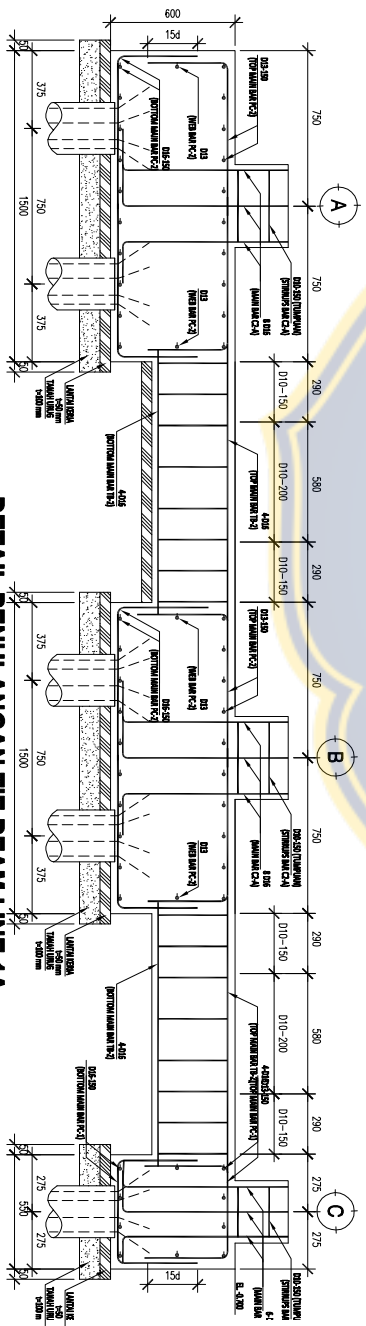

DETAIL PENJANGKANTIE BEAM LINE 1A
SKALA 1:30

NOTE

CONCRETE QUALITY :
BECON
PIECAP, TIE BEAM = K-250
COLUMN, BEAM, SLAB = K-250
RESI
LUM BUD 40 U40 (BECON)
POUS BTP 24 U24 (RAM)

REVISION

DATE	REVISION

PROJECT

THE CONSTRUCTION OF INTEGRATED
LABORATORY BUILDING FOR THE
AND ADMINISTRATION OF THE UNIVERSITY OF JEMBER

PROJECT SUPERVISION CONSULTANT

ENGINEER/AR/IN/EN/CONSTR/STRUKTUR/PT. NINDYA KARYA

CONTRACTOR

PT. HUTAJAYA KARYA - PT. NINDYA KARYA (JV)

APPROVED BY	DATE	SIGN
M. PRATIWI/AR/IT		
M. PRATIWI/IT		

CHIEF BY	DATE	SIGN

SHOP DRAWING

DRAWING GROUP
TRAINING CENTER
DIVISION
STRUKTUR
DRAWING TITLE
DENAH TIE BEAM

SCALE	SHEET	DRAWING NO
1:350	1	90.STRUC.102

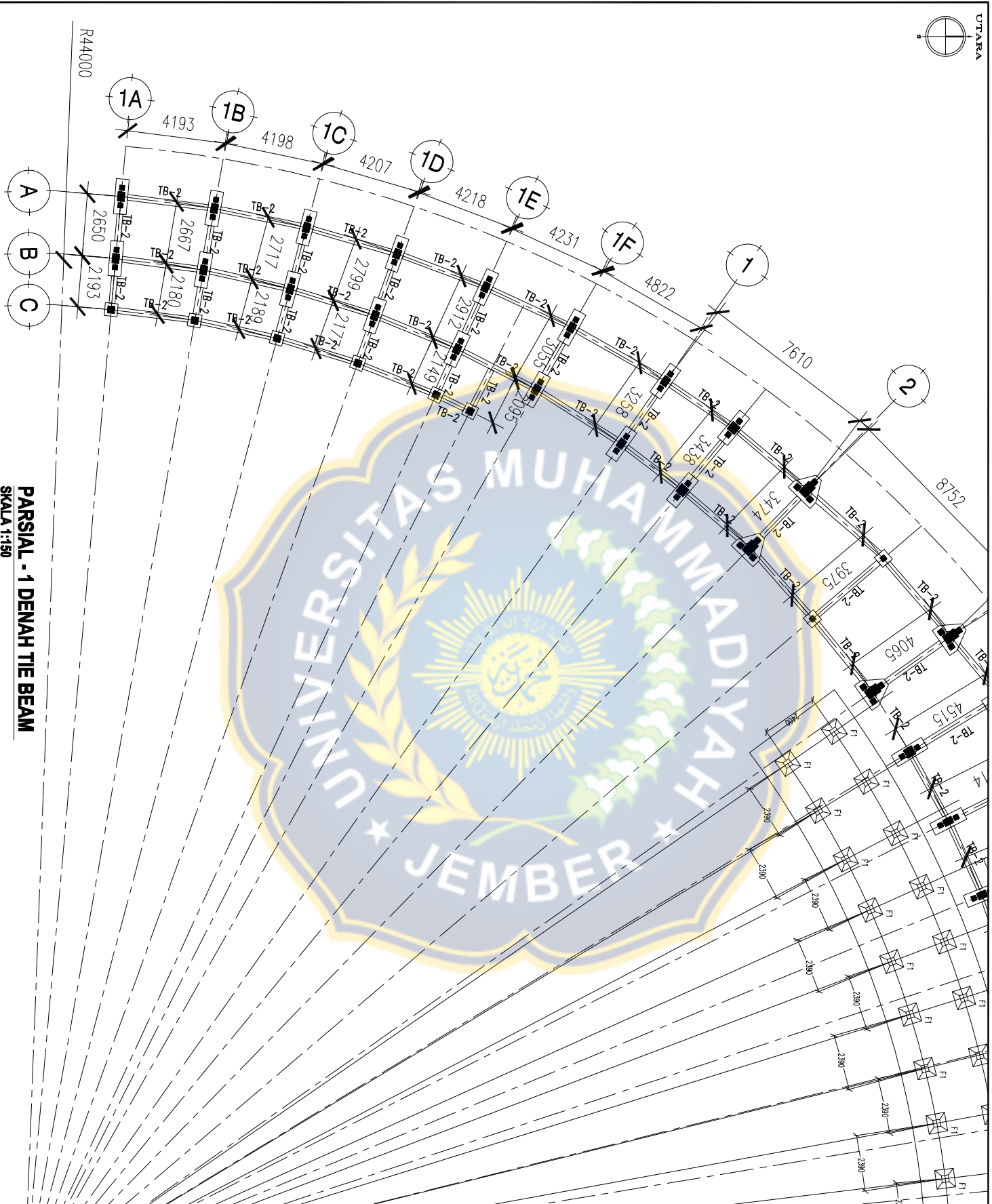
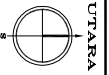

PARSIAL - 1 DENAH TIE BEAM
SKALA 1:150

NOTE

CONCRETE QUANTITY:
 BEAM
 RIBCUP, TIE BEAM = K-250
 COLUMN, BEAM, SLAB = K-250
 RESI
 LUKA BILD 40 UMB (DEFROM)
 POLIS BTP 24 U2 (RAIN)

REVISION

DATE PROJECT

THE CONSTRUCTION OF INTEGRATED
 LABORATORY BUILDING FOR THE
 AND ADMINISTRATION OF THE UNIVERSITY OF JEMBER

PROJECT SUPERVISION CONSULTANT

PT. HUTAJAYA KARYA - PT. NINDYA KARYA
 (CV)

CONTRACTOR

PT. HUTAJAYA KARYA - PT. NINDYA KARYA
 (CV)

APPROVED BY: DATE: SIGN:

CHIEF BY: DATE: SIGN:

DRAWN: DATE: SIGN:

SHOP DRAWING

DRAWING GROUP
 TRAINING CENTER
 DIVISION
STRUKTUR
 DRAWING TITLE

PARSIAL - 1 DENAH TIE BEAM

SCALE	2	DRAWING NO	8037014.004
SHEET	4		

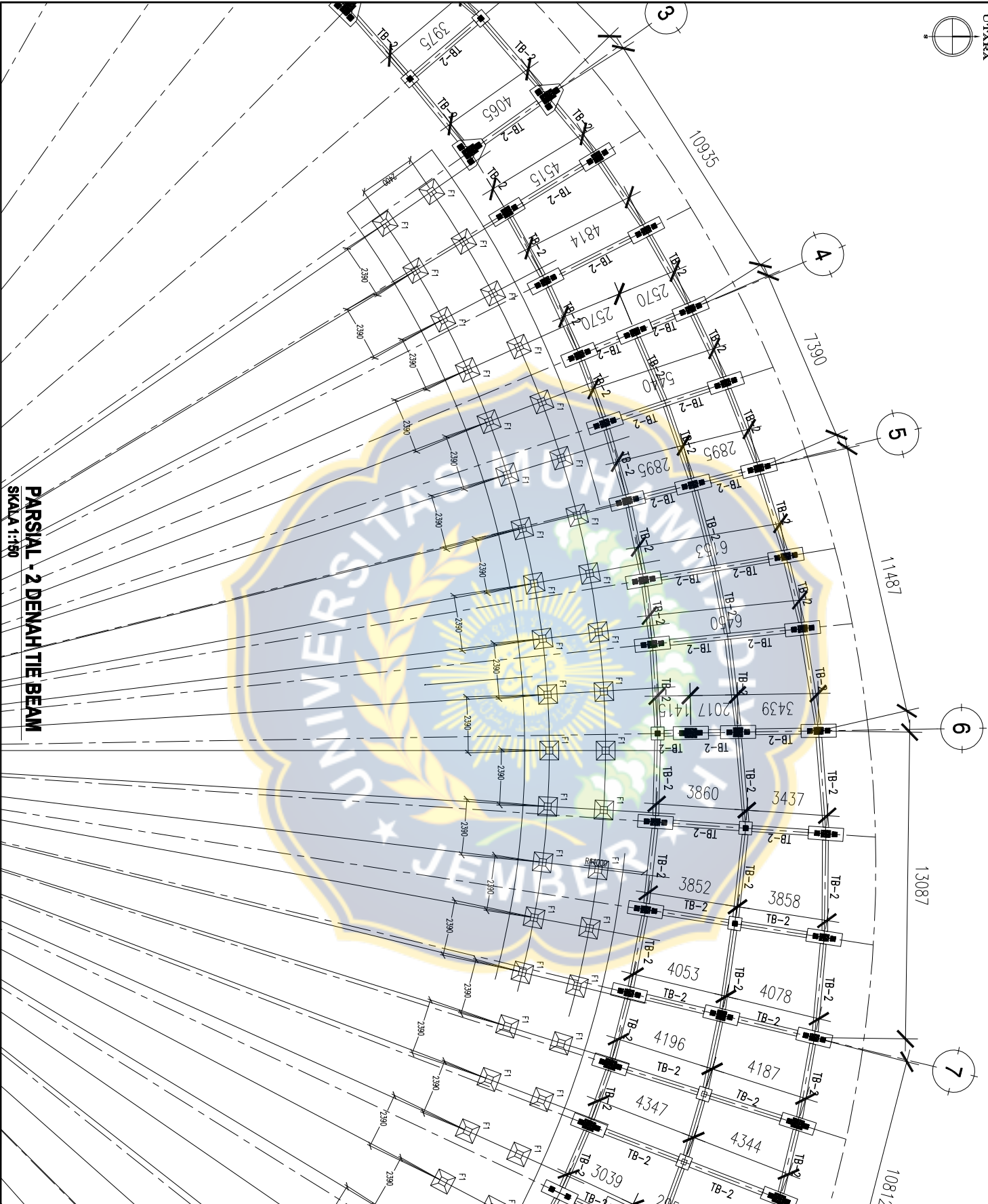

PARSIAL - 2 DENAH TIE BEAM
SKALA 1:150

NOTE

CONCRETE QUALITY :

BECON
 PILECAP, TIE BEAM = K-250
 COLUMN, BEAM, SLAB = K-230
 RESI
 LUKU BUND 40 UAG (BERFORM)
 POUSS BIMP 24 U24 (RUM)

DATE

REVISION

PROJECT

THIS CONSTRUCTION OF INTEGRATED
 LAMPUNG UNIVERSITY OF TECHNOLOGY
 AND AFFILIATED OF THIS UNIVERSITY OF JEMBER

PROJECT SUPERVISION CONSULTANT

ENGINEER'S NAME AND SIGNATURE

DATE

SIGN

CONTRACTOR

CONTRACTOR

PT. HUTAJAYA KARYA - PT. NINDYA KARYA (CV)

APPROVED BY

DATE

SIGN

M. PRATIKO A. ET

DATE

SIGN

W. HANIKH A. ET

DATE

SIGN

AHMAD HENDRI A. ET

DATE

SIGN

TRIA M. W. W. ET

DATE

SIGN

R. O. M. O

DATE

SIGN

SHOP DRAWING

DRAWING GROUP

TRAINING CENTER

DIVISION

STRUKTUR

DRAWING TITLE

PARSIAL - 2 DENAH TIE BEAM

SCALE SHEET DRAWING NO 1:150 3 4 S03TR01.0028

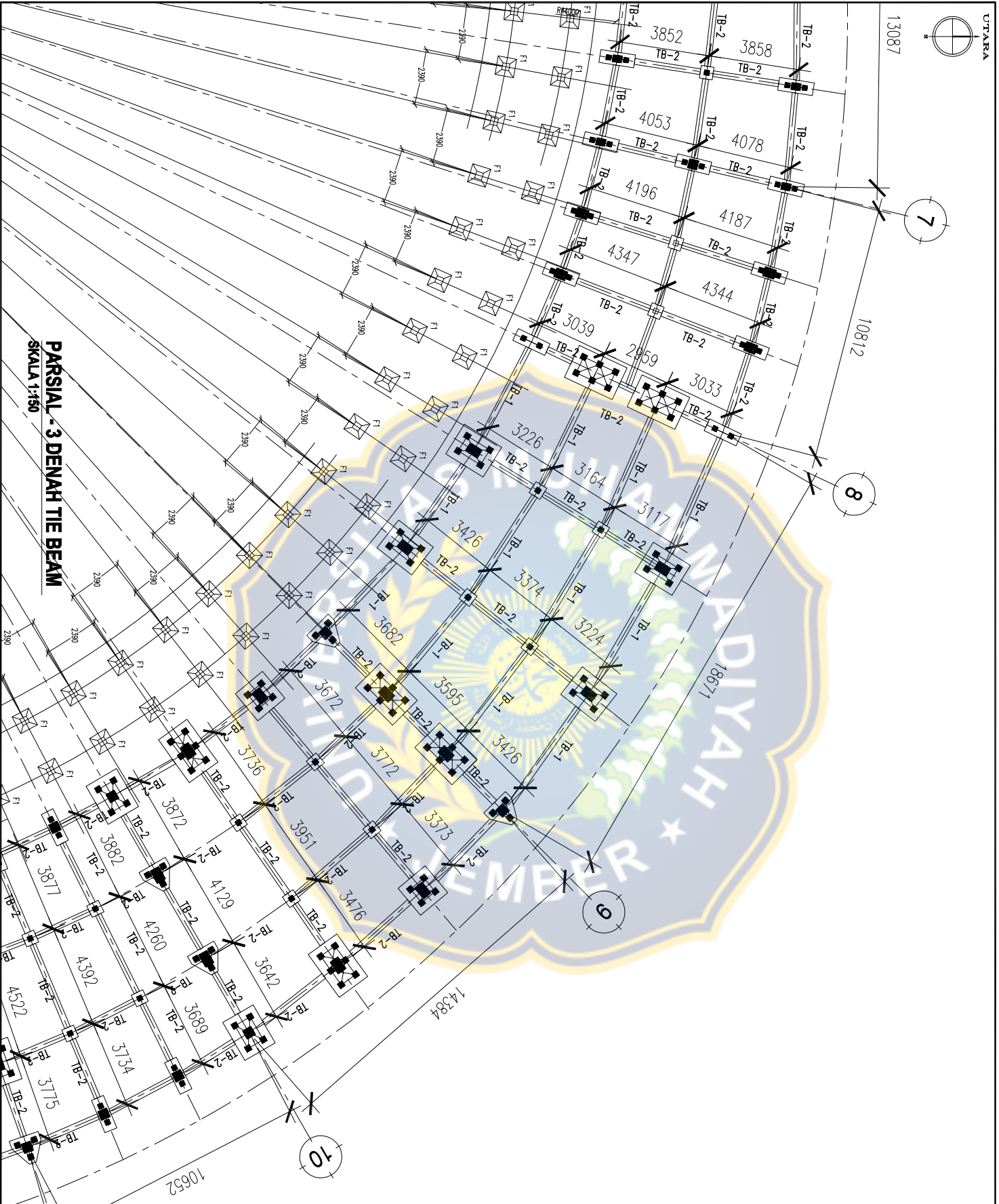

PARSIAL - 3 DENAH TIE BEAM
SKALA 1:150

NOTE

CONCRETE QUALITY :

BECON
PIECAP, TIE BEAM = K-250
COLUMN, BEAM, SLAB = K-250

RESI
LINK BIRD 40 UMB (BERFORM)
POLUS SMP 24 U24 (RUM)

DATE	REVISION

PROJECT SUPERVISION CONSULTANT

PT. HUTAJAYA KARYA - PT. NINDYA KARYA (CV)

APPROVED BY: DATE: SIGN:

DESIGNED BY: DATE: SIGN:

CHECKED BY: DATE: SIGN:

DRAWN BY: DATE: SIGN:

R.O.M.O. DRAWN:

CONTRACTOR

PT. HUTAJAYA KARYA - PT. NINDYA KARYA (CV)

APPROVED BY: DATE: SIGN:

DESIGNED BY: DATE: SIGN:

CHECKED BY: DATE: SIGN:

DRAWN BY: DATE: SIGN:

R.O.M.O. DRAWN:

DIVISION

STRUKTUR

DRAWING TITLE

DRAWING GROUP

TRAINING CENTER

PARSIAL - 3 DENAH TIE BEAM

SCALE 1:150

SHEET 4

DRAWING NO. 8

803/101/1000

UTARA

13087

10812

18671

14384

10652

7

8

6

10

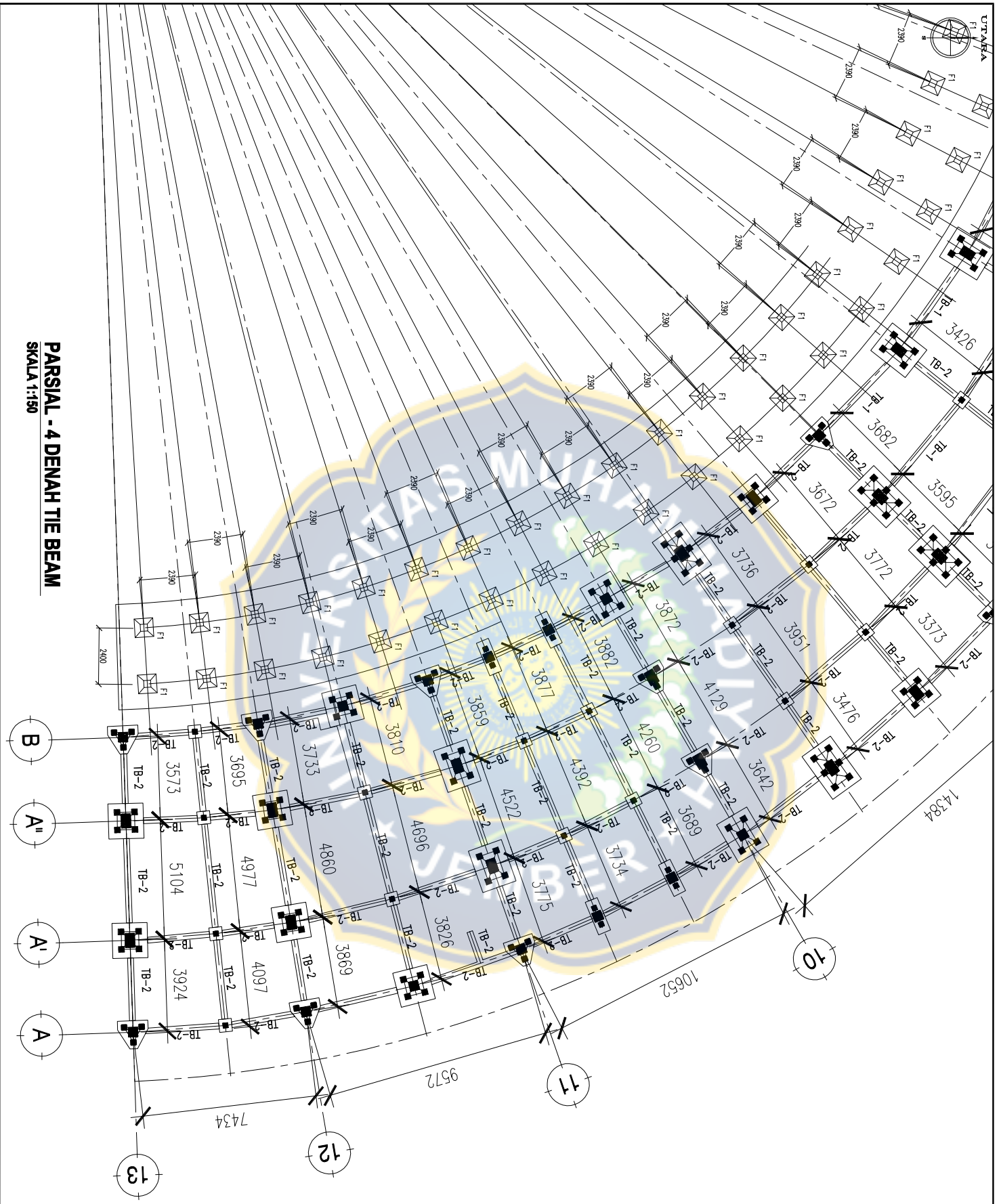

PARSIAL - 4 DENAH TIE BEAM
SKALA 1:150

NOTE

CONCRETE QUANTITY:
 BECON
 PIECEUP TIE BEAM = K-250
 COLUMN, BEAM, SLAB = K-250
 RESI
 LUKU BUND 40 UAH (DEFORM)
 POLUS BHP 24 U24 (RUM)

DATE	REVISION

PROJECT

THE CONSTRUCTION OF INTEGRATED
 LAMPUNG UNIVERSITY OF TECHNOLOGY
 AND AGRICULTURE OF THE UNIVERSITY OF LAMPUNG

PROJECT SUPERVISION CONSULTANT

PT. HUTAJAYA KARYA - PT. NINDYA KARYA
 (CV)

CONTRACTOR

APPROVED BY: DATE: SIGN:

APPROVED BY: DATE: SIGN:

APPROVED BY: DATE: SIGN:

APPROVED BY: DATE: SIGN:

APPROVED BY: DATE: SIGN:

APPROVED BY: DATE: SIGN:

APPROVED BY: DATE: SIGN:

SCALE	SHEET	DRAWING NO
1:150	8	8037101.0009

SHOP DRAWING

DRAWING GROUP
 TRAINING CENTER

DIVISION
 STRUKTUR

DRAWING TITLE
 PARISIAL - 4 DENAH TIE BEAM

LAMPIRAN
DAFTAR RIWAYAT HIDUP

Data Pribadi

Nama Lengkap : Bakdiatil Ahda
Tempat, Tanggal Lahir : Lumajang, 01 – 09 – 1997
Jenis Kelamin : Perempuan
Tinggi Badan : 155 cm
Agama : Islam
Kewarganegaraan : Indonesia
Alamat : Desa Umbul RT 01 RW 01 Kec. Kedungjajang
Kab. Lumajang
No Telp : 081216056694
Alamat Email : bakdiatilahda01@gmail.com



Pendidikan Formal

Sekolah Dasar : SD Negeri Umbul 01, Tahun 2004 - 2010
Sekolah Menengah Pertama : SMP Negeri 4 Lumajang, Tahun 2010 - 2013
Sekolah Menengah Atas : SMA PGRI 1 Lumajang, Tahun 2013 - 2016
Universitas : Universitas Muhammadiyah Jember 2016 - 2020